







OPERATING INSTRUCTIONS

---

***R-671***  
***Audio/Video Receiver***

# Introduction

## READ THIS BEFORE OPERATING YOUR UNIT

 <div style="border: 1px solid black; padding: 2px; display: inline-block; text-align: center;"> <b>CAUTION</b>  <small>RISK OF ELECTRIC SHOCK DO NOT OPEN</small> </div> 	 <p>This symbol is intended to alert the user to the presence of uninsulated "dangerous voltage" within the product's enclosure that may be of sufficient magnitude to constitute a risk of electric shock to persons.</p>
<p><b>CAUTION</b> : TO REDUCE THE RISK OF ELECTRIC SHOCK, DO NOT REMOVE COVER (OR BACK). NO USER-SERVICEABLE PARTS INSIDE. REFER SERVICING TO QUALIFIED SERVICE PERSONNEL.</p>	 <p>This symbol is intended to alert the user to the presence of important operating and maintenance (servicing) instructions in the literature accompanying the appliance.</p>

**WARNING** : TO REDUCE THE RISK OF FIRE OR ELECTRIC SHOCK, DO NOT EXPOSE THIS APPLIANCE TO RAIN OR MOISTURE.

### Note to CATV System Installer :

This reminder is provided to call the CATV system installer's attention to Article 820-40 of the NEC that provides guidelines for proper grounding and, in particular, specifies that the cable ground shall be connected to the grounding system of the building, as close to the point of cable entry as practical.

### FCC INFORMATION

This equipment has been tested and found to comply with the limits for a Class B digital device, pursuant to Part 15 of the FCC Rules. These limits are designed to provide reasonable protection against harmful interference in a residential installation. This equipment generates, uses and can radiate radio frequency energy and, if not installed and used in accordance with the instructions, may cause harmful interference to radio communications. However, there is no guarantee that interference will not occur in a particular installation. If this equipment does cause harmful interference to radio or television reception, which can be determined by turning the equipment off and on, the user is encouraged to try to correct the interference by one or more of the following measures:

- Reorient or relocate the receiving antenna.
- Increase the separation between the equipment and receiver.
- Connect the equipment into an outlet on a circuit different from that to which the receiver is connected.
- Consult the dealer or an experienced radio/TV technician for help.

Caution : Any changes or modifications in construction of this device which are not expressly approved by the party responsible for compliance could void the user's authority to operate the equipment.

### FOR YOUR SAFETY

<b>U.S.A CANADA</b>	<b>120 V</b>	<p>Units shipped to the U.S.A and Canada are designed for operation on 120 V AC only.</p> <p>Safety precaution with use of a polarized AC plug. However, some products may be supplied with a nonpolarized plug.</p> <p><b>CAUTION</b> : To prevent electric shock, match wide blade of plug to wide slot, fully insert.</p> <p><b>ATTENTION</b> : Pour éviter chocs électriques, introduire la lame la plus large de la fiche dans la borne correspondante de la prise et pousser jusqu' au fond.</p>
<ul style="list-style-type: none"> <li>• Avoid high temperatures. Allow for sufficient heat dispersion when installed on a rack.</li> <li>• Keep the set free from moisture, water, and dust.</li> <li>• Do not let foreign objects in the set.</li> <li>• Handle the power cord carefully. Hold the plug when unplugging the cord.</li> <li>• Unplug the power cord when not using the set for long periods of time.</li> <li>• Do not obstruct the ventilation holes.</li> <li>• Do not let insecticides, benzene, and thinner come in contact with the set.</li> <li>• Never disassemble or modify the set in any way.</li> </ul>		

# SAFETY INSTRUCTION

1. **Read Instructions** - All the safety and operating instructions should be read before the product is operated.
2. **Retain instructions** - The safety and operating instructions should be retained for future reference.
3. **Heed Warnings** - All warnings on the product and in the operating instructions should be adhered to.
4. **Follow Instructions** - All operating and use instructions should be followed.
5. **Cleaning** - Unplug this product from the wall outlet before cleaning. Do not use liquid cleaners or aerosol cleaners. Use a damp cloth for cleaning.
6. **Attachments** - Do not use attachments not recommended by the product manufacturer as they may cause hazards.
7. **Water and Moisture** - Do not use this product near water - for example, near a bath tub, wash bowl, kitchen sink, or laundry tub; in a wet basement, or near a swimming pool; and the like.
8. **Accessories** - Do not place this product on an unstable cart, stand, tripod, bracket, or table. The product may fall, causing serious injury to a child or adult, and serious damage to the product. Use only with a cart, stand, tripod, bracket, or table recommended by the manufacturer, or sold with the product. Any mounting of the product should follow the manufacturer's instructions, and should use a mounting accessory recommended by the manufacturer.
9. A product and cart combination should be moved with care. Quick stops, excessive force, and uneven surfaces may cause the product and cart combination to overturn.
10. **Ventilation** - Slots and openings in the cabinet are provided for ventilation and to ensure reliable operation of the product and to protect it from overheating, and these openings must not be blocked or covered. The openings should never be blocked by the product on a bed, sofa, rug, or other similar surface. This product should not be placed in a built-in installation such as a bookcase or rack unless proper ventilation is provided or the manufacturer's instructions have been adhered to.
11. **Power Sources** - This product should be operated only from the type of power source indicated on the marking label. If you are not sure of the type of power supply to your home, consult your product dealer or local power company. For products intended to operate from battery power, or other sources, refer to the operating instructions.
12. **Grounding or Polarization** - This product may be equipped with a polarized alternating-current line plug (a plug having one blade wider than the other). This plug will fit into the power outlet only one way. This is a safety feature. If you are unable to insert the plug fully into the outlet, try reversing the plug. If the plug should still fail to fit, contact your electrician to replace your obsolete outlet. Do not defeat the safety purpose of the polarized plug.  
Alternate Warnings - This product is equipped with a three-wire grounding-type plug, a plug having a third (grounding) pin. This plug will only fit into a grounding-type power outlet. This is a safety feature. If you are unable to insert the plug into the outlet, contact your electrician to replace your obsolete outlet. Do not defeat the safety purpose of the grounding-type plug.
13. **Power-Cord Protection** - Power-supply cords should be routed so that they are not likely to be walked on or pinched by items placed upon or against them, paying particular attention to cords at plugs, convenience receptacles, and the point where they exit from the product.
14. **Outdoor Antenna Grounding** - If an outside antenna or cable system is connected to the product, be sure the antenna or cable system is grounded so as to provide some protection against voltage surges and built-up static charges. Article 810 of the National Electrical Code, ANSI/NFPA 70, provides information with regard to proper grounding of the mast and supporting structure, grounding of the lead-in wire to an antenna discharge unit, size of



PORTABLE CART WARNING

grounding conductors, location of antenna-discharge unit, connection to grounding electrodes, and requirements for the grounding electrode. See Figure 1.

Figure 1  
Example of antenna grounding as per  
National Electrical Code, ANSI/NFPA 70

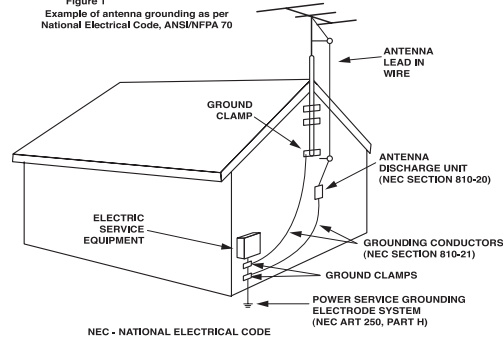

15. **Lightning** - For added protection for this product during a lightning storm, or when it is left unattended and unused for long periods of time, unplug it from the wall outlet and disconnect the antenna or cable system. This will prevent damage to the product due to lightning and power-line surges.
16. **Power Lines** - An outside antenna system should not be located in the vicinity of overhead power lines or other electric light or power circuits, or where it can fall into such power lines or circuits. When installing an outside antenna system, extreme care should be taken to keep from touching such power lines or circuits as contact with them might be fatal.
17. **Overloading** - Do not overload wall outlets, extension cords, or integral convenience receptacles as this can result in a risk of fire or electric shock.
18. **Object and Liquid Entry** - Never push objects of any kind into this product through openings as they may touch dangerous voltage points or short-out parts that could result in a fire or electric shock. Never spill liquid of any kind on the product.
19. **Servicing** - Do not attempt to service this product yourself as opening or removing covers may expose you to dangerous voltage or other hazards. Refer all servicing to qualified service personnel.
20. **Damage Requiring Service** - Unplug this product from the wall outlet and refer servicing to qualified service personnel under the following conditions:
  - a) When the power-supply cord or plug is damaged,
  - b) If liquid has been spilled, or objects have fallen into the product,
  - c) If the product has been exposed to rain or water,
  - d) If the product does not operate normally by following the operating instructions. Adjust only those controls that are covered by the operating instructions as an improper adjustment of other controls may result in damage and will often require extensive work by a qualified technician to restore the product to its normal operation.
  - e) If the product has been dropped or damaged in any way, and
  - f) When the product exhibits a distinct change in performance - this indicates a need for service.
21. **Replacement Parts** - When replacement parts are required, be sure the service technician has used replacement parts specified by the manufacturer or have the same characteristics as the original part. Unauthorized substitutions may result in fire, electric shock, or other hazards.
22. **Safety Check** - Upon completion of any service or repairs to this product, ask the service technician to perform safety checks to determine that the product is in proper operating condition.
23. **Wall or Ceiling Mounting** - The product should be mounted to a wall or ceiling only as recommended by the manufacturer.
24. **Heat** - The product should be situated away from heat sources such as radiators, heat registers, stoves, or other products (including amplifiers) that produce heat.

## CONTENTS

<b>Introduction</b>	
• READ THIS BEFORE OPERATING YOUR UNIT .....	1
• SAFETY INSTRUCTION .....	2
<b>System Connections</b> .....	4
<b>Front Panel Controls</b> .....	10
<b>Universal Remote Controls</b> .....	12
• OPERATING COMPONENTS WITH REMOTE CONTROL .....	14
• REMOTE CONTROL OPERATION RANGE .....	14
• LOADING BATTERIES .....	14
• USING FUNCTIONS OF REMOTE CONTROL .....	15
<b>Speaker Setup</b> .....	18
• SETTING THE SPEAKER SETUP MANUALLY .....	19
• SETTING THE SPEAKER SETUP AUTOMATICALLY (AUTO SPEAKER SETUP) .....	21
<b>Operations</b>	
• LISTENING TO A PROGRAM SOURCE .....	24
• SURROUND SOUND .....	27
• ENJOYING SURROUND SOUND .....	29
• LISTENING TO RADIO BROADCASTS .....	34
• RECORDING .....	36
• DIGITAL AUDIO RECORDING WITH MD RECORDER .....	37
• OTHER FUNCTIONS .....	38
<b>Using the OSD</b>	
• CURRENT STATUS DISPLAY .....	39
<b>OSD Menu Settings</b> .....	39
• SETTING THE SPEAKER SETUP .....	41
• SELECTING THE FUNCTION .....	44
• SELECTING THE SURROUND MODE .....	46
• SETTING THE CH LEVEL SETUP .....	47
<b>Troubleshooting Guide</b> .....	49
<b>Specifications</b> .....	50
<b>Setup Code Table</b> .....	51

# System Connections

- Do not plug the AC input cord into the wall AC outlet until all connections are completed.
- Be sure to observe the color coding when connecting audio, video and speaker cords.
- Make connections firmly and correctly. If not, it can cause loss of sound, noise or damage to the receiver.

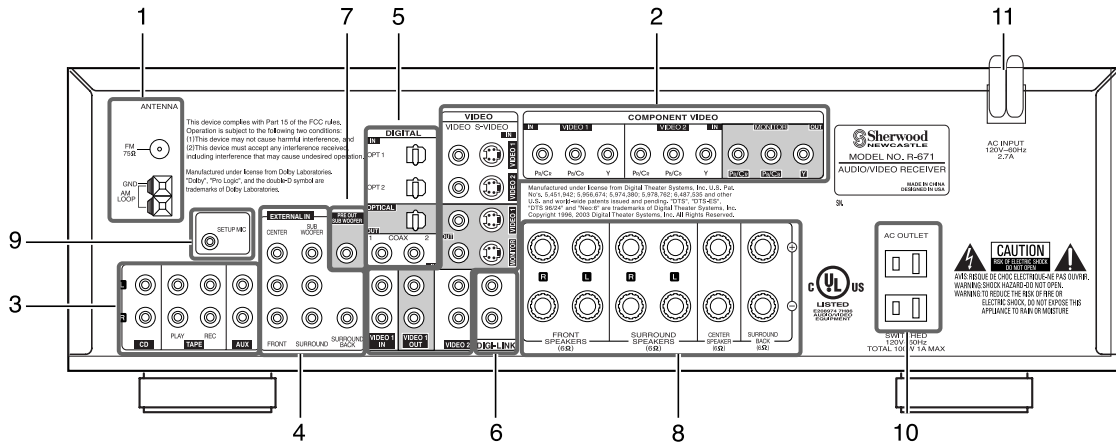

## 1. CONNECTING ANTENNAS

FM Indoor Antenna

FM Outdoor Antenna

- Change the position of the FM indoor antenna until you get the best reception of your favorite FM stations.
- A 75Ω outdoor FM antenna may be used to further improve the reception. Disconnect the indoor antenna before replacing it with the outdoor one.

AM Loop Antenna

AM Outdoor Antenna

- Place the AM loop antenna as far as possible from the receiver, TV set, speaker cords and the AC input cord and set it to a direction for the best reception.
- If the reception is poor with the AM loop antenna, an AM outdoor antenna can be used in place of the AM loop antenna.

## 2. CONNECTING VIDEO COMPONENTS

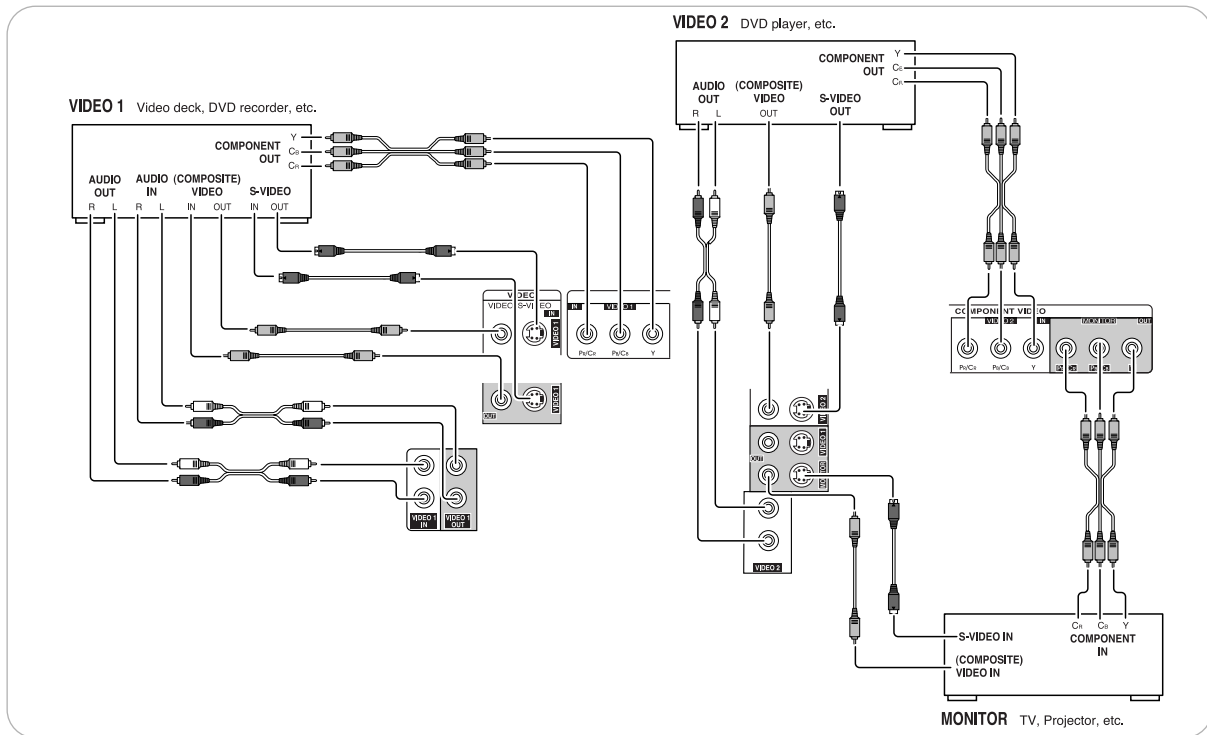

- There are three types of video jacks (COMPONENT, S-VIDEO, (composite) VIDEO) for connecting video components. Connect them to the corresponding video jacks according to their capability.
- For your reference, the excellence in picture quality is as follows : “COMPONENT” > “S-VIDEO” > “(composite) VIDEO”.
- When making COMPONENT VIDEO connections, connect “Y” to “Y”, “Pb/Cb” to “Cb” (or “B-Y”, “PB”) and “Pr/CR” to “CR” (or “R-Y”, “PR”).
- When connecting to video recording component such as video deck, DVD recorder, etc., you must use the same type of video jacks that you did connect to video playback components such as DVD player, LD player, etc.
- This unit is equipped with a function that up-converts composite video or S-Video signals to component video signals or down-converts S-Video signals to composite video signals and outputs them from the MONITOR OUTs. Because of this, one of three types of MONITOR OUT jacks can be connected to the monitor TV regardless of how the video components are connected to VIDEO IN jacks of this unit.
- Connect the video components, referring to the following table.

**Relationship between the video input signal and video output signal**

Video input signals			MONITOR OUTs		
COMPONENT	S-VIDEO	(COMPOSITE) VIDEO	COMPONENT	S-VIDEO	(COMPOSITE) VIDEO
x	x		Component video	Composite video	Composite video
x		x	S-Video	S-Video	S-Video
x			S-Video	S-Video	Composite video
	x	x	Component	x	x
	x		Component	Composite video	Composite video
		x	Component	S-Video	S-Video
			Component	S-Video	Composite video

**Notes :**

- In such a case of making only COMPONENT VIDEO connections between this receiver and video component, while viewing a movie via MONITOR COMPONENT OUTs, if the OSD menu operation is performed with the OSD, CURSOR control ( , , , ), ENTER buttons, etc., the picture is automatically turned off and only the OSD menu is displayed.
- When S-Video signals and composite video signals are input into this receiver, even though the OSD menu operation is performed, the OSD menu cannot be displayed via MONITOR COMPOSITE OUT.
- When Sherwood DVD player such as V-768, etc. is connected to the DIGI-LINK jack for system control, you should connect the DVD player to the “ VIDEO 2” jacks of this unit. Because, if the PLAY button, etc. is pressed on the DVD player, the VIDEO 2 is automatically selected as an input source on this unit. Then playback, etc. starts.

### 3. CONNECTING AUDIO COMPONENTS

- The AUX jacks may be connected to an additional audio component such as a CD player, a tape deck, etc.

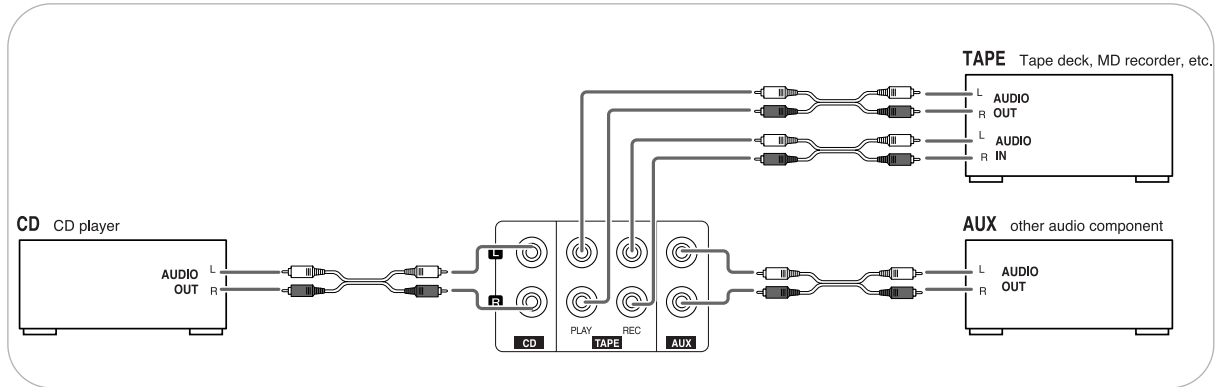

### 4. CONNECTING EXTERNAL INs

- Use these jacks to connect the corresponding outputs of a DVD player or external decoder, etc. that has 6 or 7 channel analog audio outputs
- In case of 6 channel outputs, do not connect this SURROUND BACK input to your audio component. (For details, refer to the operating instructions of the component to be connected.)

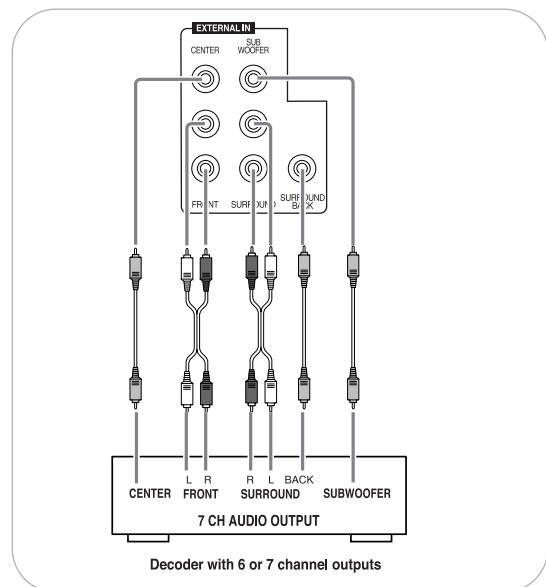

### 5. CONNECTING DIGITAL INs and OUT

- The OPTICAL and the COAXIAL DIGITAL OUTs of the components that are connected to CD and VIDEO 1~VIDEO 3 of this unit can be connected to these DIGITAL INs.
- A digital input should be connected to the components such as a CD player, LD player, DVD player, etc. capable of outputting DTS Digital Surround, Dolby Digital or PCM format digital signals, etc.
- If the component with OPTICAL IN jack is connected to the OPTICAL OUT jack of this unit, you can record the high quality sound of CDs, etc. without degradation.
- For details, refer to the operating instructions of the component connected.
- When making the COAXIAL DIGITAL connection, be sure to use a 75 Ω COAXIAL cord, not a conventional AUDIO cord.
- All of the commercially available optical fiber cords cannot be used for the equipment. If there is an optical fiber cord which cannot be connected to your equipment, consult your dealer or nearest service organization.

Note :

- Be sure to make either a OPTICAL or a COAXIAL DIGITAL connection on each component. (You don't need to do both.)

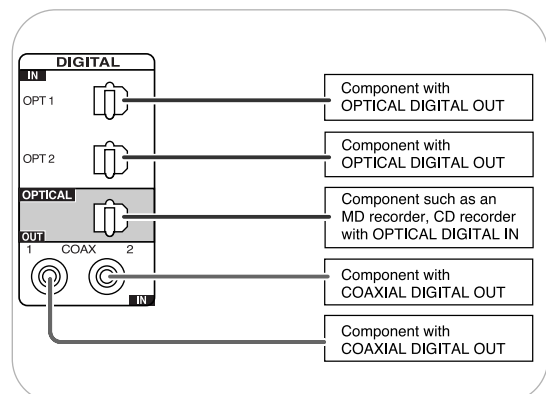

## 6. CONNECTING SYSTEM CONTROL

- Connect this jack to the DIGI LINK jack of the external Sherwood component that uses the DIGI LINK II or III remote control system.

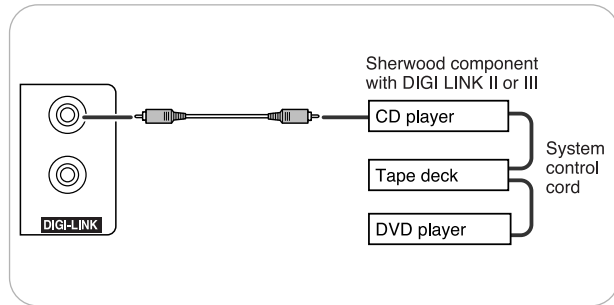

## 7. SUBWOOFER PREOUT connection

- To emphasize the deep bass sounds, connect a powered subwoofer.

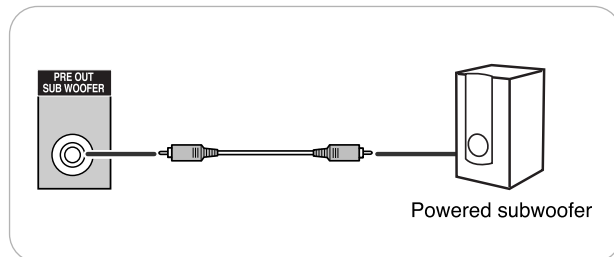

## 8. CONNECTING SPEAKERS

- Be sure to connect speakers firmly and correctly according to the channel(left and right) and the polarity(+ and -). If the connections are faulty, no sound will be heard from the speakers, and if the polarity of the speaker connection is incorrect, the sound will be unnatural and lack bass.
- For installing the speakers, refer to "Speaker placement" on page 8.
- After installing the speakers, first adjust the speaker settings according to your environment and speaker layout.(For details, refer to "Speaker Setup" on page 18.)

### Caution :

- Be sure to use the speakers with the impedance of 6 ohms or above.
- Do not let the bare speaker wires touch each other or any metal part of this unit. This could damage this unit and/or the speakers.

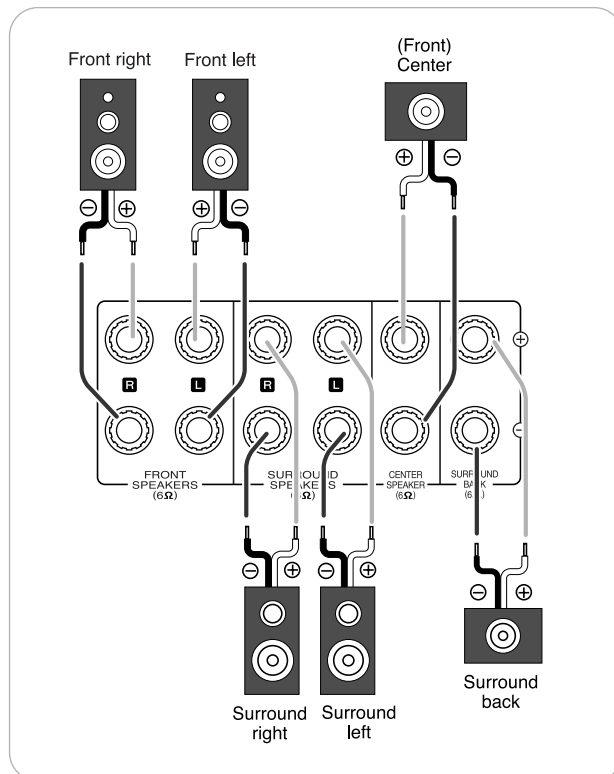



## Speaker placement

Ideal speaker placement varies depending on the size of your room and the wall coverings, etc. The typical example of speaker placement and recommendations are as follows :

### Front left and right speakers and center speaker

- Place the front speakers with their front surfaces as flush with TV or monitor screen as possible.
- Place the center speaker between the front left and right speakers and no further from the listening position than the front speakers.
- Place each speaker so that sound is aimed at the location of the listener's ears when at the main listening position.

### Surround left and right speakers

- Place the surround speakers approximately 1 meter (40 inches) above the ear level of a seated listener on the direct left and right of them or slightly behind.

### Surround back speaker

- Place the surround back speaker at the rear center facing the front at a slightly higher position (0 to 10 inches) than the surround speakers.
- We recommend installing the surround back speaker at a slightly downward facing angle. This effectively prevents the surround back channel signals from reflecting off the TV or screen at the front center, resulting in interference and making the sense of movement from the front to the back less sharp.

### Subwoofer

- The subwoofer reproduces powerful deep bass sounds.  
Place a powered subwoofer anywhere in the front as desired.

#### Notes :

- When using a conventional TV , to avoid interference with the TV picture, use only magnetically shielded front left and right and center speakers.
- To obtain the best surround effects, the speakers except the subwoofer should be full range speakers.

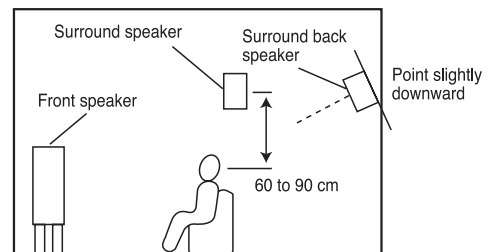
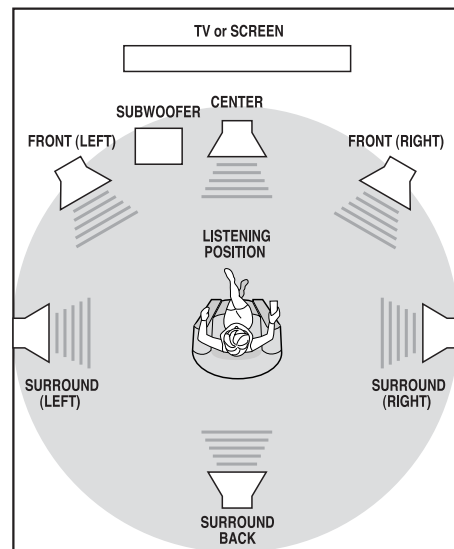

## 9. CONNECTING MICROPHONE

- To use Auto Speaker Setup function, connect the microphone to the SETUP MIC jack.(For details, refer to “SETTING THE SPEAKER SETUP AUTOMATICALLY(AUTO SPEAKER SETUP)” on page 21.)

**Note:**

- Because the microphone for Auto Speaker Setup is designed for use with this receiver, do not use a microphone other than the one supplied with this receiver.

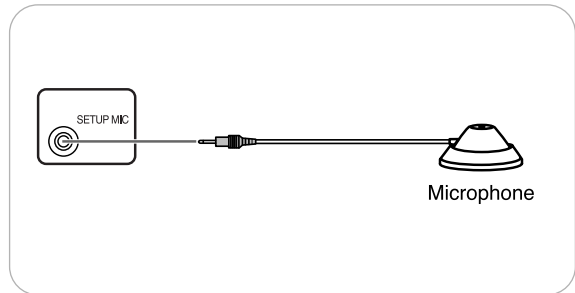

## 10. SWITCHED AC OUTLETS

- These outlets are switched on(power-on mode) and off(standby mode) according to power control as follows(Maximum total capacity is 100 W, 1 A).

- Standby mode - Switched AC outlet off
- Power-on mode - Switched AC outlet on

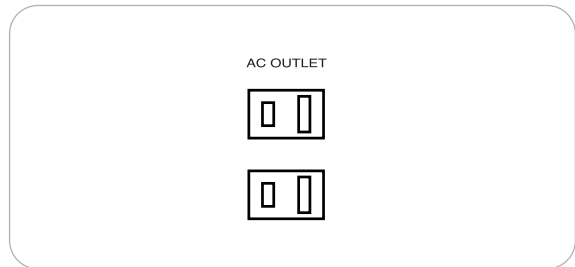

## 11. AC INPUT CORD

- Plug this cord into a wall AC outlet.

# Front Panel Controls

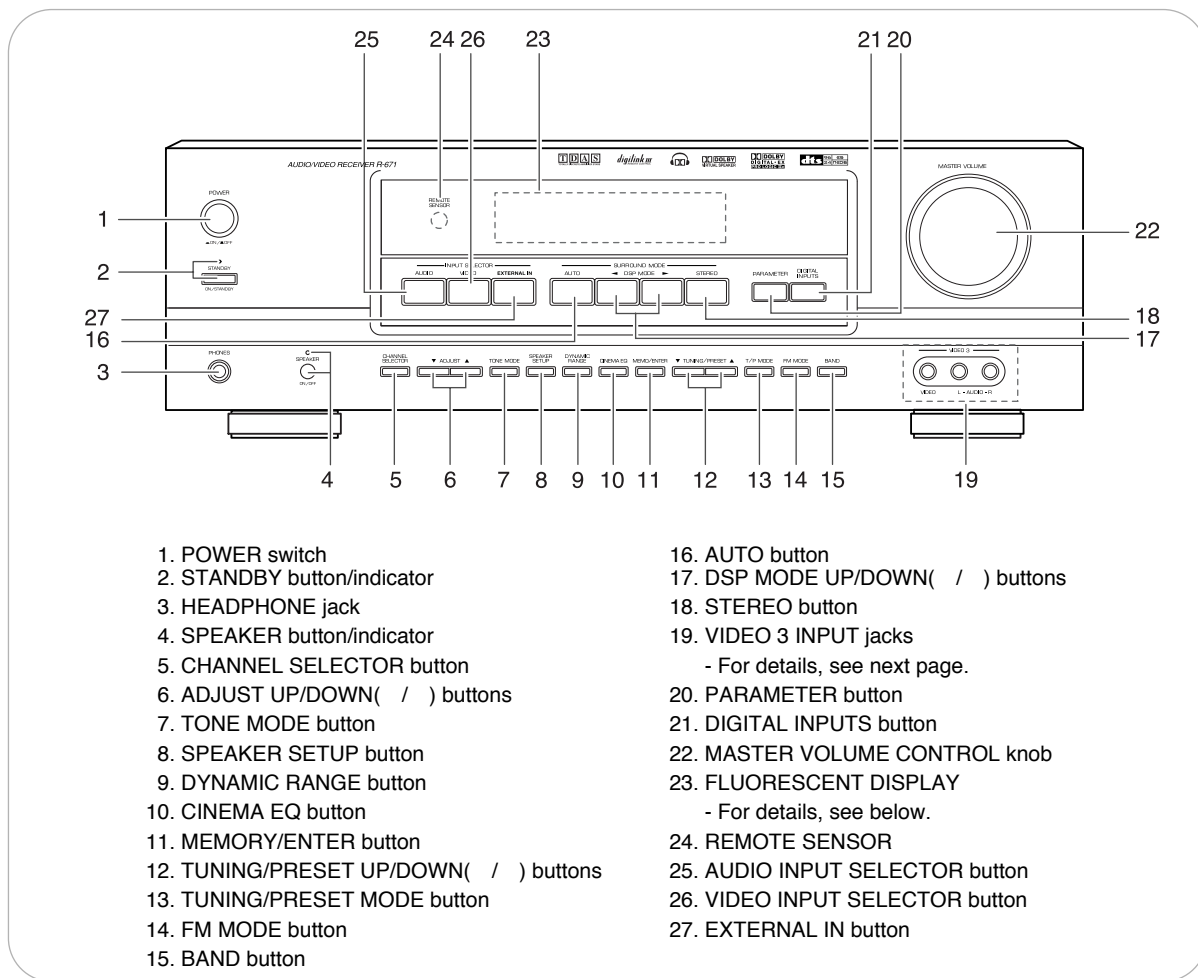

## FLUORESCENT DISPLAY

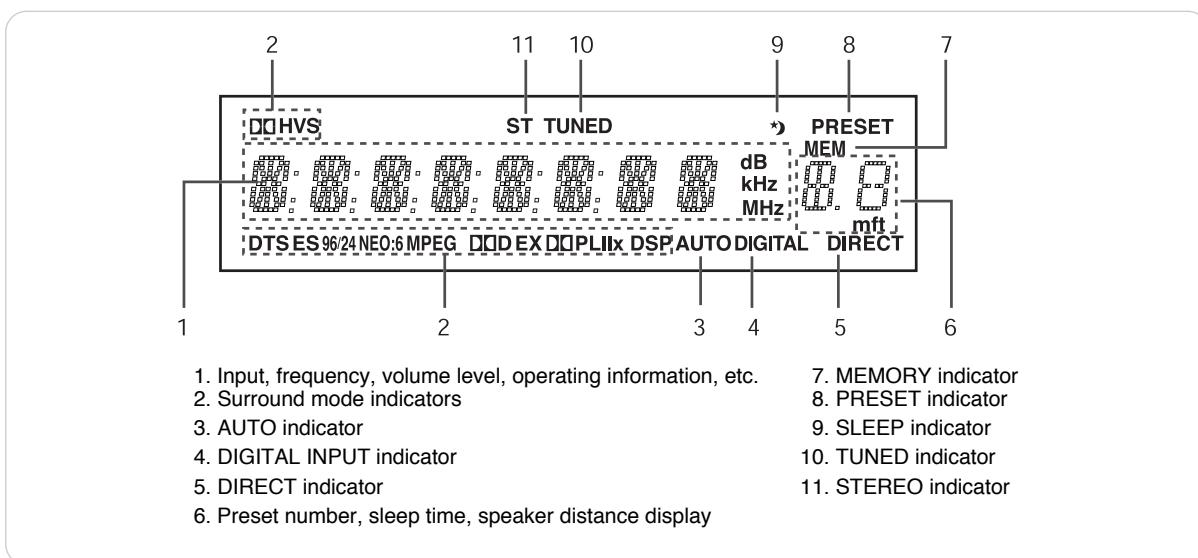

## VIDEO 3 INPUT JACKS

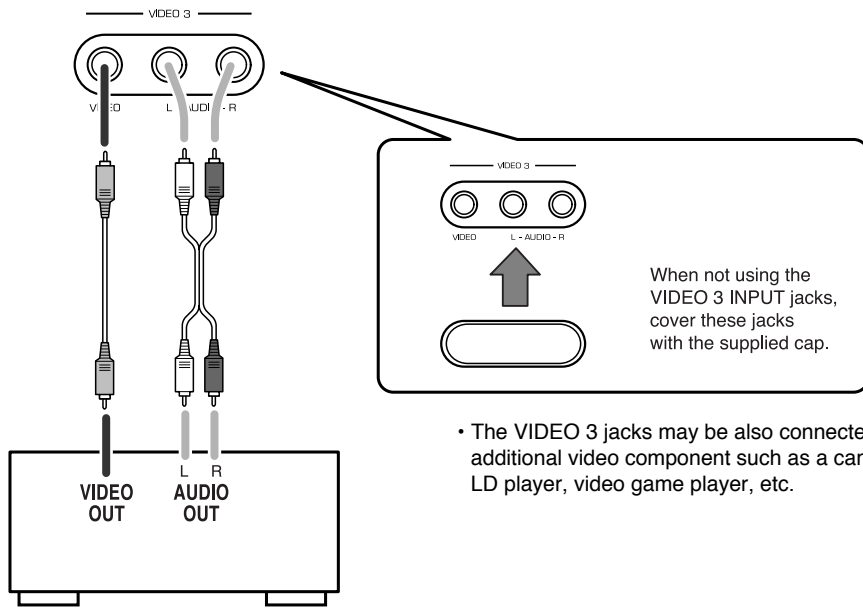

- The VIDEO 3 jacks may be also connected to an additional video component such as a camcorder, LD player, video game player, etc.

**VIDEO 3** Camcorder, video game player, etc.

# Universal Remote Controls

This universal remote control can operate not only this receiver but also most popular brands of audio and video components such as CD players, cassette decks, TVs, cable boxes, VCRs, DVD players, satellite receivers, etc.

- To operate 7 components other than this receiver, you should enter the setup code for each component. (For details, refer to "USING FUNCTIONS OF REMOTE CONTROL" on page 15.)







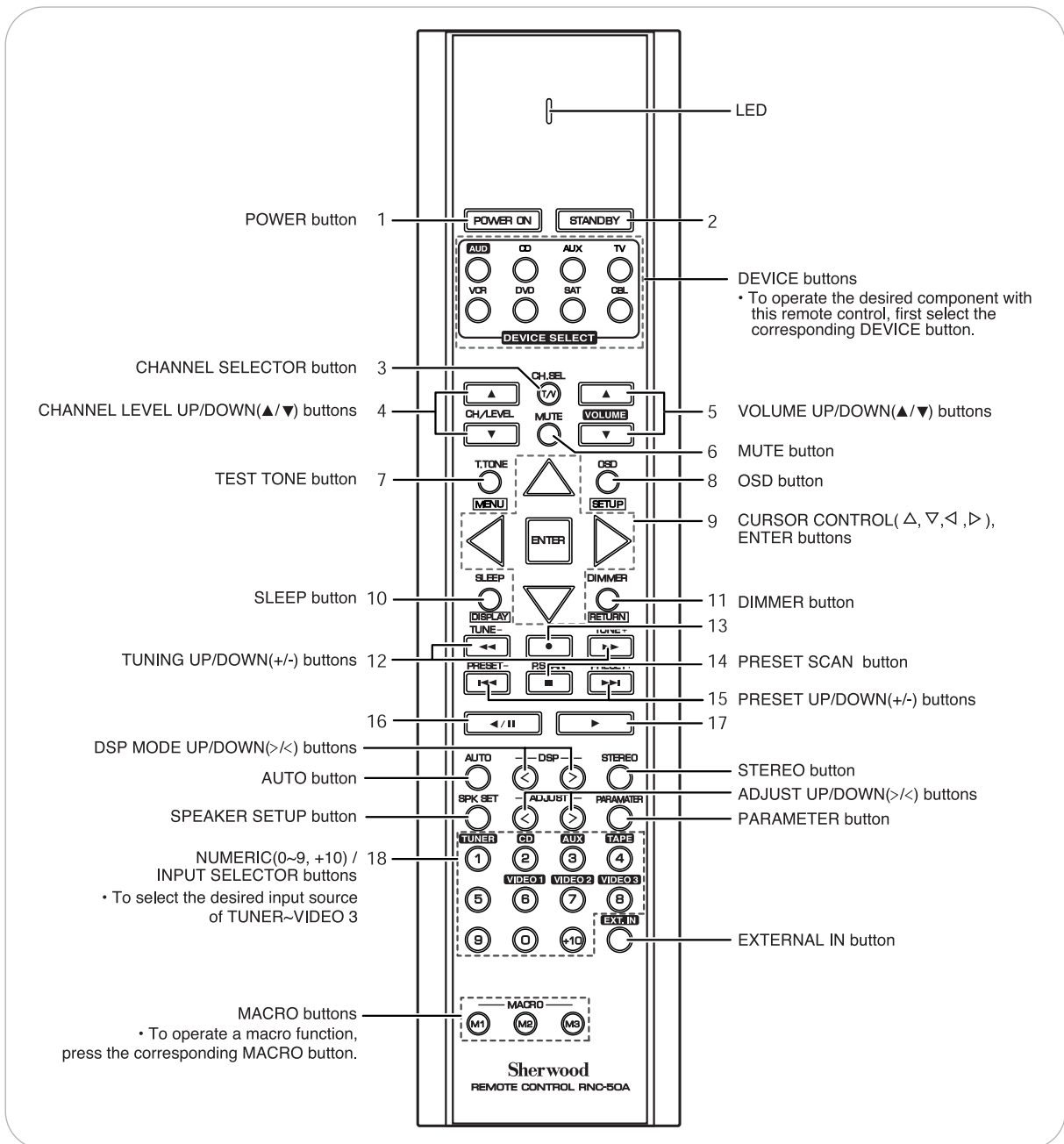











## Digi link system remote controls

This remote control can also operate Sherwood compatible components bearing the DIGI LINK (II or III) logo.

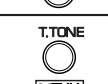
- For digi link system remote control operation, first make the DIGI LINK connections between Sherwood components.
- The numbered buttons on the remote control have different functions in different device modes. For details, refer to "FUNCTION TABLE of the NUMBERED BUTTONS" on the following page 13.

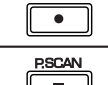
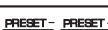
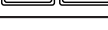
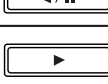

## FUNCTION TABLE of the NUMBERED BUTTONS

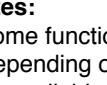
Device to be controlled	 (for CD player)	 (for tape deck)	 (for TV)	 (for VCR)	 (for DVD player)	 (for satellite receiver)	 (for cable box)
Button symbol							
1 	POWER ON	POWER ON	POWER ON	POWER ON	POWER ON	POWER ON	POWER ON
2 	STANDBY (POWER OFF)	STANDBY (POWER OFF)	STANDBY (POWER OFF)	STANDBY (POWER OFF)	STANDBY (POWER OFF)	STANDBY (POWER OFF)	STANDBY (POWER OFF)
3 	—	—	INPUT SELECTOR	INPUT SELECTOR	—	INPUT SELECTOR	INPUT SELECTOR
4 	—	—	CHANNEL LEVEL UP/DOWN(▲/▼)	CHANNEL LEVEL UP/DOWN(▲/▼)	—	CHANNEL LEVEL UP/DOWN(▲/▼)	CHANNEL LEVEL UP/DOWN(▲/▼)
5 	—	—	VOLUME UP/DOWN(▲/▼)	VOLUME UP/DOWN(▲/▼)	—	VOLUME UP/DOWN(▲/▼)	VOLUME UP/DOWN(▲/▼)
6 	—	—	MUTE	MUTE	—	MUTE	MUTE
7 	—	—	—	—	MENU	—	—
8 	—	—	—	—	SETUP	—	—
9 	—	—	—	—	CURSOR CONTROL	—	—
					ENTER		
10 	—	—	—	—	DISPLAY	—	—
11 	—	—	—	—	RETURN	—	—
12 	—	REWIND(◀) / FAST FORWARD(▶)	—	REWIND(◀) / FAST FORWARD(▶)	REVERSE SEARCH(◀◀) / FORWARD SEARCH(▶▶)	—	—
13 	—	RECORD	—	RECORD	—	—	—
14 	STOP	STOP	—	STOP	STOP	—	—
15 	REVERSE SKIP(◀◀) / FORWARD SKIP(▶▶)	—	—	—	REVERSE SKIP(◀◀) / FORWARD SKIP(▶▶)	—	—
16 	PAUSE	REVERSE PLAY	—	PAUSE	PAUSE	—	—
17 	PLAY	FORWARD PLAY	—	PLAY	PLAY	—	—
18 	NUMERIC	—	NUMERIC	NUMERIC	NUMERIC	NUMERIC	NUMERIC

### Notes:

- Some functions for each component may not be available or may work differently.
- Depending on other kinds of components that are available for each DEVICE button, some functions may not be available or may work differently, too.
- For details about functions, refer to the operating instructions of each component.

## OPERATING COMPONENTS WITH REMOTE CONTROL

- 1** Enter the setup code for each component other than this receiver you wish to control. For details, refer to “Entering a setup code” on page 15.
- 2** Turn on the component you want to operate.
- 3** Press the DEVICE button on the remote control corresponding to the component you wish to operate.
- 4** Aim the remote control at the REMOTE SENSOR of the component you wish to control and press the button corresponding to the operation you want.
  - When operating a Sherwood CD player or tape deck using digi link system remote control, aim the remote control at the REMOTE SENSOR of this receiver.
  - However, to operate a Sherwood DVD player, aim at the REMOTE SENSOR of the corresponding component.

## REMOTE CONTROL OPERATION RANGE

- Use the remote control unit within a range of about 7 meters (23 feet) and angles of up to 30 degrees aiming at the remote sensor.

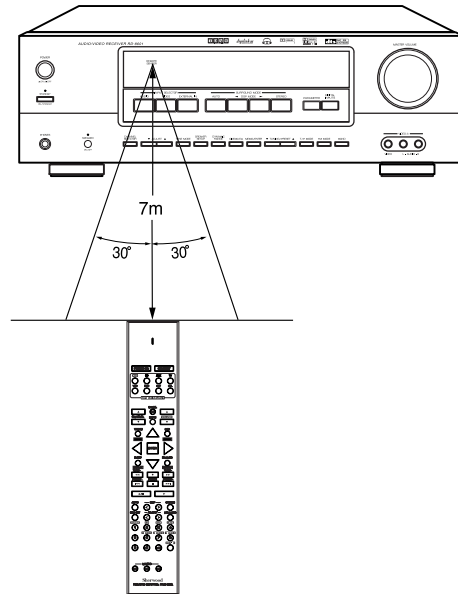

## LOADING BATTERIES

- When the remote control does not operate, the old batteries should be replaced. In this case, load new batteries within several minutes after removing old batteries.
- If the batteries are removed or have been exhausted for a longer period of time, memorized contents will be cleared. Should this happen, you should memorize them again.

- 1** Remove the cover.

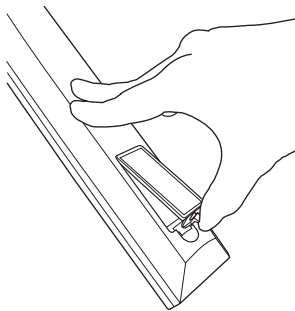

- 2** Load two batteries (“AAA” size) matching the polarity.

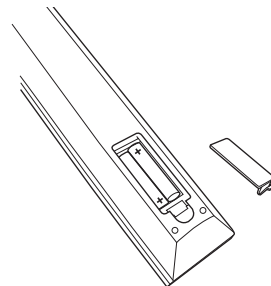

- Remove the batteries when they are not used for a long time.
- Do not use the rechargeable batteries (Ni-Cd type).
- Be sure to use alkaline batteries.

## USING FUNCTIONS OF REMOTE CONTROL

- This remote control can control up to 8 different components.
- Before operating audio and video components other than this receiver with using this remote control, the setup code for each component should be entered.
- For system remote control operation, "000" was stored previously in the memory of the device button "CD" for Sherwood CD player, "DVD" for Sherwood DVD player and "AUX" for Sherwood tape deck respectively as its factory setup code. So, you don't need to enter its code for each Sherwood component except in such a case that its code does not work.

### Entering a setup code

**1** Turn on the component you want to control.

**2** Find the setup codes according to the type and the brand name of your component, referring to "Setup Code Table" on page 51.

**3** Press and hold down both the "ENTER" button and the desired one of the DEVICE buttons for more than 1 second.

**4** Enter a 3 digit code, aiming the remote control at the remote sensor on the component.  
Example) When entering "001".

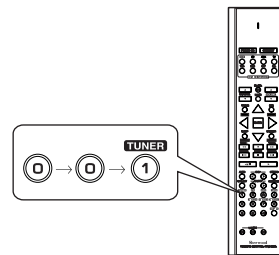
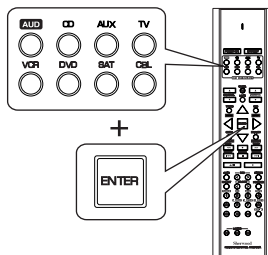

- The LED will flicker once.

#### Note:

- The "AUD" button is unavailable for the audio components other than this receiver.

- If entering is performed successfully, the LED will flicker twice.
- To be sure that the setup code is correct, press the POWER(or STANDBY) button.  
If your component is tuned off, the setup code is correct.
- When your component is not turned off, repeat the above steps to , trying each code for your component until you find one that works.

#### Notes:

- If the LED did not flicker twice, then repeat the above steps to and try entering the same code again.
- Manufacturers may use different setup codes for the same product category. For that reason, it is important that you check to see if the code you have entered operates as many controls as possible. If only a few functions operate, check to see if another code will work with more buttons.
- When operating a Sherwood CD player or tape deck using the system remote control, aim the remote control at the REMOTE SENSOR on this receiver.  
However, in case of Sherwood DVD player and MD recorder, aim it at the REMOTE SENSOR on the corresponding component.

**5** Repeat the above steps to for each of your components.



### Using a punch-through function

This remote control may be programmed to operate either the AUDIO volume punch-through or the TV volume and/or TV channel punch-through in conjunction with any of the eight components controlled by this remote control. For example, since this receiver will likely be used as the sound system while watching TV, you may want to adjust this receiver's volume although this remote control is set to control the TV.

- When programming this remote control for the AUDIO volume punch-through, press and hold down both "AUD" button and "VOLUME" button for more than 1 second.

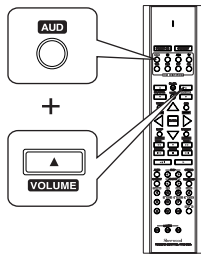

- If programming is performed successfully, the LED will flicker twice.
- When you want either TV volume or TV channel punch-through, press and hold down both "TV" button and either "VOLUME" or "CH/LEVEL" button for more than 1 second.

#### Note :

- If you use one of AUDIO and TV volume punch-through functions, you cannot use the other.

### Removing a punch-through function

- When removing the AUDIO volume punch-through, press and hold down both "AUD" button and "VOLUME" button for more than 1 second.

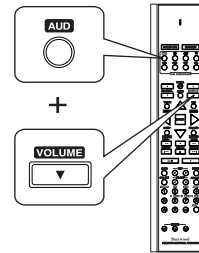

- If removing is performed successfully, the LED will flicker twice.
- When you want to remove either TV volume or TV channel punch-through, press and hold down both "TV" button and either "VOLUME" or "CH/LEVEL" button for more than 1 second.

### Removing all punch-through functions

Press and hold down both "AUD" button and "AUTO" button for more than 1 second.

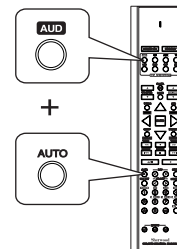

- If removing all punch-through functions is performed successfully, the LED will flicker twice.

### Programming a macro function

- The macro function enables you to program a series of button operations (up to 10) on this remote control into a single button.
- You can store up to three separate macro command sequences into "M1", "M2" and "M3" buttons.

**1** Press and hold down both "ENTER" button and one of three NUMERIC buttons ("1"~"3") corresponding to "M1"~"M3" buttons for more than 1 second.

Example) When programming a series of button operations into "M1" button.

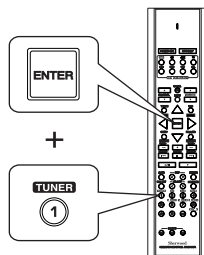

- If the macro mode is entered, the LED will flicker once.

**3** Press "ENTER" button.

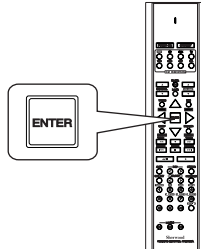

- If the programming is performed successfully, the LED will flicker twice.

### Operating a macro function

- Aim the remote control at the REMOTE SENSORS of the components to be controlled and press the MACRO button you want.  
Example) When pressing "M1" button.

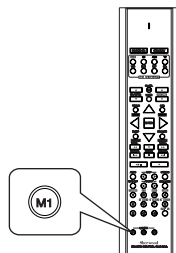

**2** Press the operation buttons you want to program in order.

Note:

You should press the corresponding DEVICE buttons before pressing each operation button.  
Example) When playing a DVD on the DVD player connected to VIDEO 2 jacks of this receiver.

1. Press "AUDIO" button to control this receiver.
2. Press "POWER" button to turn this receiver on.
3. Press "AUDIO" button to control this receiver.
4. Press "VIDEO 2(7)" button to select the desired input source.
5. Press "DVD" button to control the DVD player.
6. Press "POWER" button to turn the DVD player on.
7. Press "DVD" button to control the DVD player.
8. Press " " button to start playback.

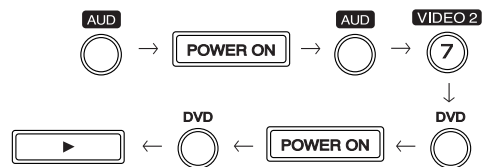

#### To remove a macro program

- When removing a macro program, perform the above steps and , but ignore the step .

#### To change a macro program

- When a new macro program is stored into a MACRO button with performing the above steps to , the previous macro program is cleared from the memory of the MACRO button.

Notes:

- The codes programmed into a MACRO button will be transmitted at an interval of 0.5 seconds. However, some components may not be able to complete one operation in 0.5 seconds and may miss the next code.  
In this case, the macro function cannot control the corresponding components correctly.
- Be sure to use the remote control within the remote control operation range of the components.
- Depending on the operation status of the components, etc., the macro function cannot control the corresponding components correctly.

# Speaker Setup

- After you have installed this receiver and connected all the components, you should adjust the speaker settings for the optimum sound acoustics according to your environment and speaker layout.
- Even when you change speakers, speaker positions, or the layout of your listening environment, you should adjust the speaker settings, too.

### About the speaker size

The composition of the signals output from the different channels and the frequency response are adjusted automatically according to the combination of speakers actually being used.

- Select “Large” or “Small” not according to the actual size of the speaker but according to the speaker’s capacity for playing low frequency (bass sound below frequency set for the Crossover Frequency mode and below) signals.

**Large :** Select this when connecting speakers that can fully reproduce sounds below crossover frequency(\*) of your speaker.

**Small :** Select this when connecting speakers that cannot fully reproduce sounds below crossover frequency.

When this setting is selected, sounds below crossover frequency are sent to the subwoofer or speakers which are set to “Large”(when not using a subwoofer).

**None :** Select this when no speakers are connected.

When this is selected, sounds are sent to the speakers which are not set to None.

**Yes / None :** Select the desired depending on whether a subwoofer is connected or not.

- (\*) : **Crossover frequency** is the frequency (Hz) below which the bass sound of each main speakers is to output from the subwoofer or from speakers which are set to “Large” (when not using a subwoofer).
- Refer to the operating instructions of the speakers to be connected. If the frequency range of your speaker is 100 Hz ~ 20 kHz, the crossover frequency have to be set to 100 Hz(or slightly higher).
- If you do not know, try comparing the sound at both settings (setting the volume to a level low enough so as not to damage the speakers) to determine the proper setting.

### About the speaker distance

When enjoying multi-channel surround playback with Dolby Digital and DTS sources, etc., it is ideal that the center and surround speakers, etc. should be the same distance from the main listening position as the front speakers. By entering the distance between the listening position and each speaker, the delay times of center and surround speakers are automatically adjusted to create an ideal listening environment virtually as if the center and surround speakers were at their ideal locations respectively as below:

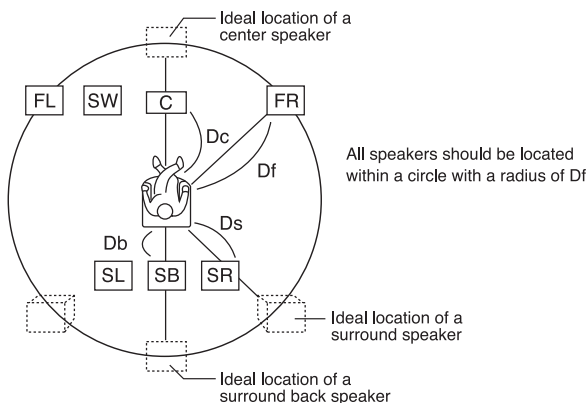

- Depending on relationship between speakers, settings possible for each speaker are as follows:

Front L/R	Center	Surr. L/R	Surr. Back	Subwoofer
Large	Large	Large	Large	Yes or None
			Small	
		Small	Small	
			None	
	Small	Large	Large	
			Small	
		Small	Small	
			None	
	None	Large	Large	
			Small	
		Small	Small	
			None	
Small	Small	Small	Yes	
		None		
	None	Small		
		None		

## SETTING THE SPEAKER SETUP MANUALLY

Note: When the SPEAKER button is set to off or the EXTERNAL IN is selected as an input source, the speaker setup procedure cannot be performed.

### Before setting the speaker setup

- Press the POWER switch to enter the standby mode and then turn the power on.

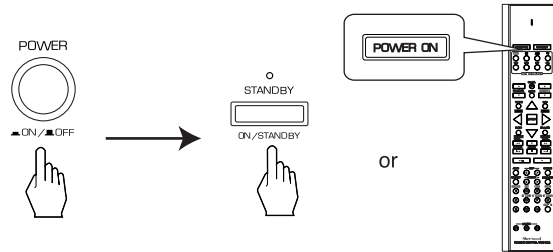

### 1 When selecting each setting mode,

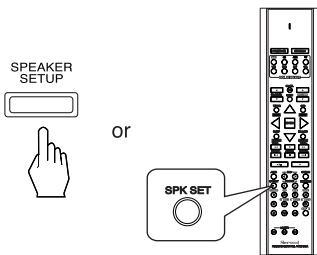

- Each time the SPEAKER SETUP button is pressed, the speaker setting mode changes in succession and is displayed for several seconds as follows.
- When the speaker setting mode disappears, press the SPEAKER SETUP button repeatedly to select the desired mode.

• When selecting the subwoofer,  
"SUB-W  $\begin{matrix} Y \\ / \backslash \\ / \backslash \end{matrix}$ "

• When selecting the front speaker size,  
"FRONT  $\begin{matrix} L \\ / \backslash \\ / \backslash \end{matrix}$ "

• When selecting the center speaker size,  
"CENTER  $\begin{matrix} L \\ / \backslash \\ / \backslash \end{matrix}$ "

• When selecting the surround speaker size,  
"SURR  $\begin{matrix} L \\ / \backslash \\ / \backslash \end{matrix}$ "

• When selecting the surround back speaker size,  
"SURR-B  $\begin{matrix} L \\ / \backslash \\ / \backslash \end{matrix}$ "

### 2 When adjusting the selected mode to the desired setting,

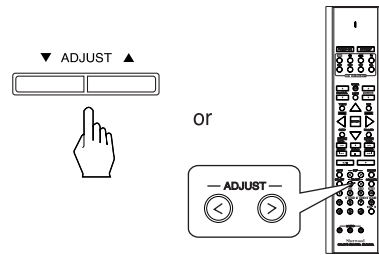

- Each time the ADJUST UP ( / ) or DOWN ( \ ) button is pressed, one of the settings is selected and displayed for several seconds as follows.

Y(es)  $\leftrightarrow$  N(one)  
• When the subwoofer is set to "N", the front speaker is automatically set to "L".

• You can select one of 2 different speaker settings.  
L  $\leftrightarrow$  S  
(L: Large, S: Small)

• You can select one of 3 different speaker settings.  
 $\begin{matrix} \leftarrow L \leftrightarrow S \leftrightarrow N \leftarrow \\ (L: Large, S: Small, N: None) \end{matrix}$

• You can select one of 3 different speaker settings.  
 $\begin{matrix} \leftarrow L \leftrightarrow S \leftrightarrow N \leftarrow \end{matrix}$

• You can select one of 3 different speaker settings.  
 $\begin{matrix} \leftarrow L \leftrightarrow S \leftrightarrow N \leftarrow \end{matrix}$

**Continued**

<ul style="list-style-type: none"> <li>When selecting the distance of front left speaker, "FRONT L 10 (ft)"</li> </ul>	→	<ul style="list-style-type: none"> <li>You can adjust the distance within the range of 1 ~ 30 feet in 1 foot intervals. 1 (ft) ~ 30 (ft)</li> </ul>
<ul style="list-style-type: none"> <li>When selecting the distance of front right speaker, "FRONT R 10 (ft)"</li> </ul>	→	<ul style="list-style-type: none"> <li>You can adjust the distance within the range of 1 ~ 30 feet in 1 foot intervals. 1 (ft) ~ 30 (ft)</li> </ul>
<ul style="list-style-type: none"> <li>When selecting the distance of center speaker, "CENTER 10 (ft)"</li> </ul>	→	<ul style="list-style-type: none"> <li>You can adjust the distance within the range of 1 ~ 30 feet in 1 foot intervals. 1 (ft) ~ 30 (ft)</li> </ul>
<ul style="list-style-type: none"> <li>When selecting the distance of surround left speaker, "SURR L 05 (ft)"</li> </ul>	→	<ul style="list-style-type: none"> <li>You can adjust the distance within the range of 1 ~ 30 feet in 1 foot intervals. 1 (ft) ~ 30 (ft)</li> </ul>
<ul style="list-style-type: none"> <li>When selecting the distance of surround right speaker, "SURR R 05 (ft)"</li> </ul>	→	<ul style="list-style-type: none"> <li>You can adjust the distance within the range of 1 ~ 30 feet in 1 foot intervals. 1 (ft) ~ 30 (ft)</li> </ul>
<ul style="list-style-type: none"> <li>When selecting the distance of surround back speaker, "SURR-B 05 (ft)"</li> </ul>	→	<ul style="list-style-type: none"> <li>You can adjust the distance within the range of 1 ~ 30 feet in 1 foot intervals. 1 (ft) ~ 30 (ft)</li> </ul>
<ul style="list-style-type: none"> <li>When selecting the crossover frequency, "FC 80 Hz"</li> </ul>	→	<ul style="list-style-type: none"> <li>You can adjust the crossover frequency within the range of 40 ~ 130 Hz in 10 Hz intervals. 40 Hz ~ 130 Hz</li> </ul>

**Notes:**

- You cannot adjust the distances of subwoofer and the speakers set to "None".
- When speakers are set to "Small", you should set the crossover frequency according to their frequency characteristics.

3

**Memorize the adjusted speaker settings.**

MEMO/ENTER



↓



or

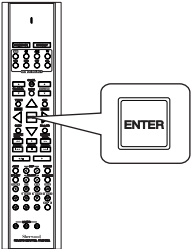

- The adjusted settings are memorized in the memory.

## SETTING THE SPEAKER SETUP AUTOMATICALLY (AUTO SPEAKER SETUP)

- Auto Speaker Setup lets you avoid troublesome listening-based speaker setup and achieve good surround sound. You should connect the microphone to the SETUP MIC jack so that this receiver can analyze the information from a series of test tones emitted from speakers and can adjust the size, distance and sound level of each speaker automatically.
- If you want to personalize your speaker setup and channel level setup by making the settings manually, perform the “SETTING THE SPEAKER SETUP MANUALLY” procedure on page 19, “Adjusting each channel level with test tone” procedure on page 31 and “Adjusting the current channel level” procedure on page 32.

Note:

- Because the microphone for Auto Speaker Setup is designed for use with this receiver, to use the auto speaker setup function, do not use a microphone other than the one supplied with this receiver.

### Before setting the speaker setup

- Press the POWER switch to enter the standby mode and then turn the power on.

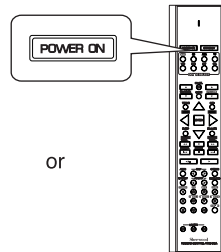

1

Connect the optional microphone to the SETUP MIC jack on the rear panel. (For details, refer to “CONNECTING MICROPHONE” on page 9.)

2

Place the microphone on a flat level surface at your normal listening position.

- If possible, use a tripod, etc. to attach the microphone at the same height as your ears would be when you are seated in your listening position.
- Ensure there are no obstacles between the speakers and the microphone.

3

Press and hold down the SPEAKER SETUP button on the front panel for more than 2 seconds to enter the auto speaker setup mode.

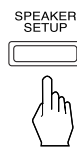

- Then “SET ALL S” is displayed.
- For your reference, the default settings for auto speaker setup are as follows:  
Speaker layout: ALL channels, Subwoofer: Yes, CUTOff frequency: 80 Hz
- When performing auto speaker setup according to the default settings, skip the step and perform the step .
- However, you can specify these settings according to the number of speakers installed and speakers’ frequency characteristics with performing the step .
- To cancel the auto speaker setup mode, press and hold down the SPEAKER SETUP button on the front panel for more than 2 seconds again.

# 4

Specify the setting condition.

## When specifying the number of speakers installed.

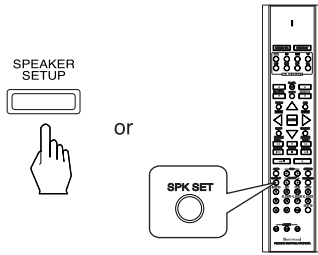

- Each time this button is pressed, the speaker layout changes as follows:

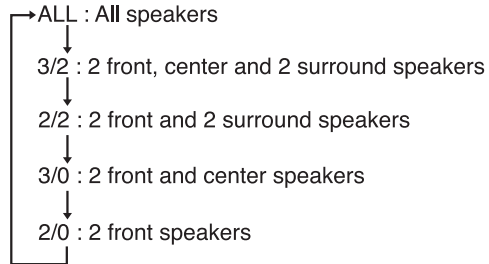

## When specifying the subwoofer or the crossover frequency.

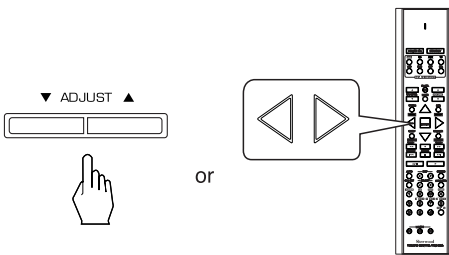

- Each time the ADJUST UP( ) or CURSOR RIGHT( ) button is pressed, the subwoofer changes as follows:

S No display  
(Subwoofer: Yes) (None)

- Each time the ADJUST DOWN( ) or CURSOR LEFT( ) button is pressed, the crossover frequency("CUT") changes within the range of 40~130 Hz in 10 Hz intervals.
- In case that the subwoofer setting is "S"(Subwoofer:Yes), if it is possible to adjust the volume and crossover frequency on your subwoofer, set the volume to about medium level (or slightly less), and set the crossover frequency to the maximum.

# 5

Start the auto speaker setup procedure.

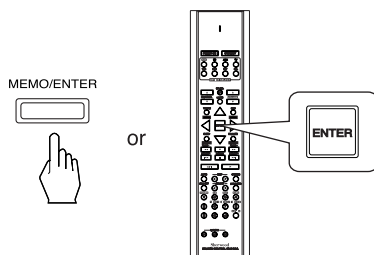

### Notes:

- Because the test tones are very loud, ensure there are no infants or small children in the room.
- For best results, ensure the room is as quiet as possible during the auto speaker setup procedure.  
If there is too much ambient noise, the results may not be satisfactory.

- Loud test tones are output from each speaker.
- To stop the auto speaker setup procedure, press the (MEMORY/) ENTER button.  
To retry the procedure, press the (MEMORY/) ENTER button again.
- After the auto speaker setup procedure has been completed, "SET MEMO" will be displayed.
- If ">ERROR<" is displayed, there may be a problem with the speaker or microphone connection.  
While displaying ">ERROR<", to retry the procedure, press the ADJUST UP( ) or CURSOR RIGHT( ) button and to exit from the procedure, press the ADJUST DOWN( ) or CURSOR LEFT( ) button.
- If retrying the procedure does not fix the problem, turn off the power and check the speaker or microphone connections.

**6** While displaying "SET MEMO", check the result of each adjustment.

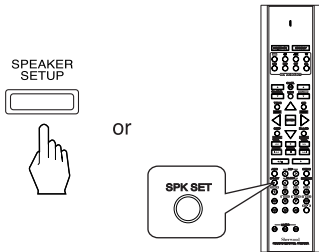

- Each time this button is pressed, the result changes as follows:  
Example)

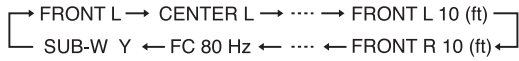

- You cannot check the channel level results. To check the channel level results, perform the auto speaker setup procedure, using the OSD menu setting procedure. (For details, refer to "When selecting the AUTO SPEAKER SETUP" on page 41.)
- If the results are not satisfactory, set the speaker setup manually. (For details, refer to "SETTING THE SPEAKER SETUP MANUALLY" on page 19.)

**7** Confirm the results.

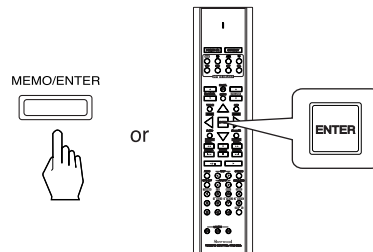

- Then "COMPLETE" is displayed and the results are memorized.



# Operations

• Note : Before operating this receiver with the supplied remote control, refer to “Universal Remote Controls” on page 12 for details about operation.

## LISTENING TO A PROGRAM SOURCE

### Before operation

- Enter the standby mode.
- The STANDBY indicator lights up.
  - When the power operation switch is in the OFF or STANDBY state, the apparatus is still connected on some AC line voltages. Please be sure to unplug the cord when you leave home for, say, a vacation.
- To switch the power off, push the POWER switch again.
- Then the power is cut off and the STANDBY indicator goes off.



**1** In the standby mode, turn the power on.

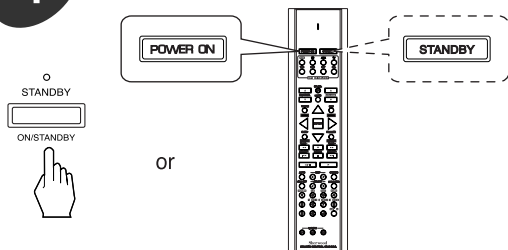

- In the operating mode, if the STANDBY button on the remote control is pressed, the receiver is turned off and enters the standby mode.
- In the standby mode, if the INPUT SELECTOR button on the remote control is pressed, the receiver is turned on automatically and the desired input is selected.

**2** Switch the speakers on.

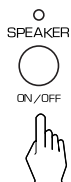

- Then the SPEAKER indicator lights up and the sound can be heard from the speakers connected to the speaker terminals.
- When using the headphone for private listening, press the SPEAKER button again to switch the speakers off.

**3**

Select the desired input source.

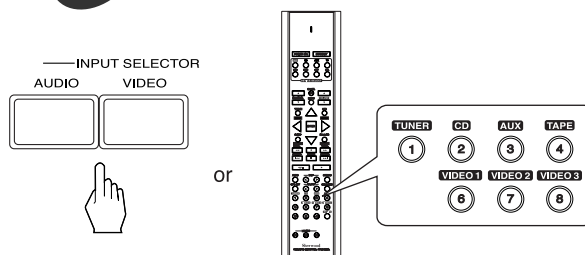

- Each time the “AUDIO” button on the front panel is pressed, the input source changes as follows;
  - TUNER → CD → TAPE → AUX → (frequency display)
- Each time the “VIDEO” button on the front panel is pressed, the input source changes as follows;
  - VIDEO 1 → VIDEO 2 → VIDEO 3 →

When selecting the EXTERNAL IN as desired,

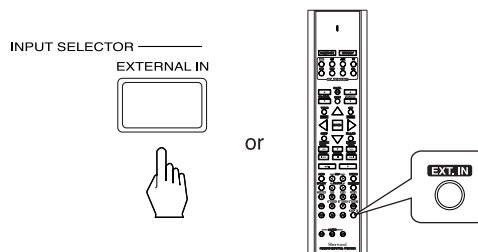

- “EXT IN” is displayed and the 7 or 6 separate analog signals from the component connected to this input can be controlled only by channel level(s) and volume depending on the surround back speaker setting.
- Press the EXTERNAL IN button or select the desired input source to cancel the external in function.
- These analog signals can be heard only, not recorded.

**When CD, VIDEO 1~3 is selected as an input source**

**4** Select the digital or analog input connected as desired.

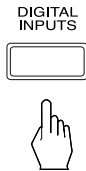

• Each time this button is pressed, the corresponding input is selected as follows ;

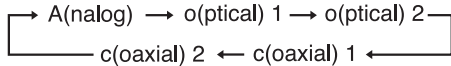

• When TUNER, TAPE, AUX or EXTERNAL IN is selected as an input source, the digital input cannot be selected.

**Notes :**

- When the selected optical or coaxial digital input is not connected, the "DIGITAL" indicator flickers, meaning no sound. (Refer to "ENJOYING SURROUND SOUND" on page 29.)
- The sound from the component connected to the selected digital input can be heard regardless of the selected input source.

**5** Operate the selected component for playback.

- When playing back the program sources with surround sound, refer to "ENJOYING SURROUND SOUND" on page 29.

**6** Adjust the (overall) volume.

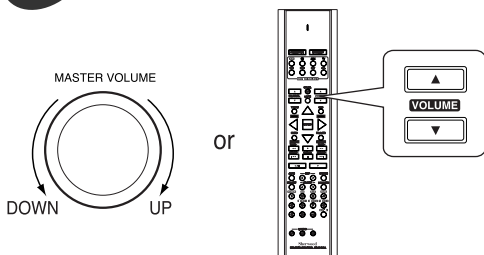

**7** To compensate for edgy or shrill movie sound tracks.

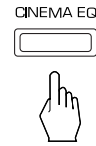

- Then "C-EQ OFF" is scrolled.
- Press it again to work, the "C-EQ ON" is scrolled.
- When 96 kHz PCM(2 CH stereo) signals are input or the SPEAKER button is set to off, the cinema EQ function does not work.

**8** To mute the sound.

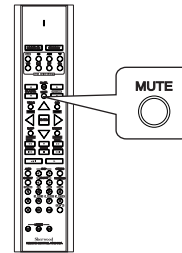

- "MUTE" will flicker.
- To resume the previous sound level, press it again.

**9** To listen with the headphones.

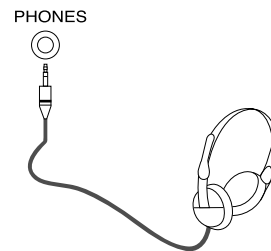

- Ensure that the SPEAKER button is set to off.
- Depending on the signal format which is being input, you can listen in different Dolby Headphone modes, stereo mode, etc. with pressing the DSP MODE (<) / (>) buttons. (For details, refer to "Listening in a Dolby Headphone mode" on page 30).

## Adjusting the tone(bass and treble)

10

Enter the tone mode.

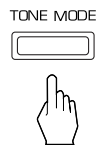

- Each time this button is pressed, the corresponding tone mode is selected and shown for several seconds as follows:

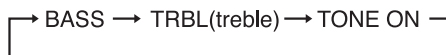

- When the tone mode is off, "TONE OFF" is shown.

11

At the desired tone mode, adjust the tone as desired.

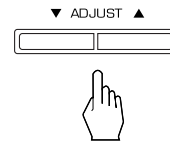

- At "TONE ON" mode, you can select "TONE OFF" mode and vice versa.  
TONE ON : When adjusting the tone for your taste.  
     ("DIRECT" indicator goes off.)  
TONE OFF : When listening to a program source without the tone effect.  
    ("DIRECT" indicator lights up.)
- In general, we recommend the bass and the treble to be set to 0(flat) level.

### Notes:

- If the tone display disappears, start from the step again.
- Extreme settings at high volume may damage your speakers.
- When the digital signals from DTS, Dolby Digital or MPEG program sources are input or the EXTERNAL IN is selected as an input source, you cannot adjust the tone and can hear a program source without the tone effect.

## SURROUND SOUND

\* This receiver incorporates a sophisticated Digital Signal Processor that allows you to create optimum sound quality and sound atmosphere in your personal Home Theater.

### Surround modes

#### DTS Digital Surround

DTS Digital Surround(also called simply DTS) is a multi-channel digital signal format which can handle higher data rates. Discs bearing the  include the recording of up to 5.1 channels of digital signals, which can be generally thought to provide better sound quality due to the lower audio compression required. It also provides wide dynamic range and separation, resulting in magnificent sound.

#### DTS - ES Extended Surround™ ( )

This is a new multi channel digital signal format which greatly improves the 360- degree surround impression and space expression thanks to further expanded surround signals, offering high compatibility with the conventional DTS format. In addition to the 5.1 channels, DTS-ES Extended Surround also offers the surround back (sometimes also referred to as "surround center") channel for surround playback with a total of 6.1 channels. DTS-ES Extended Surround includes two signal formats with different surround signal recording methods as follows:

##### • DTS-ES™ Discrete 6.1

Because the signals for 6.1 channels (including the surround back channel) are fully independent, it is possible to achieve a sense that the acoustic image are moving about freely among the background sounds surrounding the listener from 360 degrees. Though maximum performance is achieved when sound tracks recorded with this system are played using a DTS -ES decoder, when played with a conventional DTS decoder, the surround back channel signals are automatically downmixed to the surround left and surround right channels so that none of the signal components are lost.

##### • DTS - ES™ Matrix 6.1

With this format, the additional surround back channel signals undergo matrix encoding and are input to the surround left and surround right channels beforehand. During playback, they are decoded to the surround left, surround right and surround back channels. Because the bit stream format is 100% compatible with conventional DTS signals, the effect of the DTS-ES Matrix 6.1 format can be achieved even with DTS 5.1- channel signal sources. Of course, it is possible to play DTS-ES Matrix 6.1 - channel signal sources with a DTS 5.1 - channel decoder. When DTS-ES Discrete 6.1 or Matrix 6.1 sources are decoded with a DTS - ES decoder, the format is automatically detected upon decoding and the optimum surround mode is selected. However, some DTS - ES Matrix 6.1 sources may be detected as DTS sources. In this case, the DTS - ES Matrix mode should be selected manually to play these sources.

#### DTS Neo : 6™ surround

This mode applies conventional 2-channel signals such as digital PCM or analog stereo signals to the high precision digital matrix decoder used for DTS-ES Matrix 6.1 to achieve 6.1-channel surround playback. DTS Neo : 6 surround includes two modes for selecting the optimum decoding for the signal source.

##### • DTS Neo : 6 Cinema

This mode is optimum for playing movies. Decoding is performed with emphasis on separation performance to achieve the same atmosphere with 2-channel sources as with 6.1-channel sources.

##### • DTS Neo : 6 Music

This mode is suited mainly for playing music. The front left and front right signals bypass the decoder and are played directly so there is no loss of sound quality, and the effect of the surround signals from the center, surround left, surround right and surround back channels adds a natural sense of expansion to the sound field.

#### DTS 96/24

Conventional surround formats used sampling frequencies of 48 or 44.1 kHz, so 20 kHz was about the maximum playback signal frequency. With DTS 96/24, the sampling frequency is increased to 96 or 88.2 kHz to achieve a wide frequency range of over 40 kHz. In addition, this format has a resolution of 24 bits, resulting in the same frequency band and dynamic range as 96kHz / 24 bit PCM signals.

As with conventional DTS surround, DTS 96/24 is compatible with a maximum of 5.1 channels. DTS 96/24 is fully compatible with the conventional DTS surround format, so DTS 96/24 sources can be played using a conventional DTS 5.1 channel decoder.

"DTS", "DTS-ES", "DTS 96/24" and "Neo:6" are trademarks of Digital Theater Systems, Inc.

#### Dolby Digital

Dolby Digital is the multi- channel digital signal format developed by Dolby Laboratories. Discs bearing the  includes the recording of up to 5.1 channels of digital signals, which can reproduce much better sound quality, spatial expansion and dynamic range characteristics than the previous Dolby Surround effect.

#### Dolby Digital EX

This mode creates the back (sometimes also referred to as "surround center") signals from the surround left and right signals in Dolby Digital 5.1 channel source using a matrix decoder and provides 6.1 channel surround playback. For the best results, this mode should be selected during playback of sources(bearing the ) recorded in Dolby Digital

EX. With this additional channel, you can experience more dynamic and realistic moving sound especially. When Dolby Digital EX sources are decoded with a Dolby Digital EX decoder, the format is automatically detected upon decoding and the Dolby Digital EX mode is selected. However, some Dolby Digital EX sources may be detected as Dolby Digital sources. In this case, the Dolby Digital EX mode should be selected manually to play these sources.

### Dolby Pro Logic IIx surround

Dolby Pro Logic IIx decodes all stereo (2 channel ) and 5.1 channel sources and extends to 7.1channel surround playback. It delivers the most natural, full range and immersing 7.1 channel listening experience. Dolby Pro Logic IIx surround includes two modes as follows :

- **Dolby Pro Logic IIx Movie**

When enjoying movies, this mode allows you to further enhance the cinematic quality by adding processing that emphasizes the sounds of the action special effects.

- **Dolby Pro Logic IIx Music**

When listening to music, this mode allows you to further enhance the sound quality by adding processing that emphasizes the musical effects.

### Dolby Pro Logic II surround

This mode applies conventional 2-channel signals such as digital PCM or analog stereo signals as well as Dolby Surround signals, etc. to surround processing to offer improvements over conventional Dolby Pro Logic circuits. Dolby Pro Logic II surround includes Dolby Pro Logic II Movie and Dolby Pro Logic II Music like Dolby Pro Logic IIx surround.

### Dolby Virtual Speaker

This mode creates a virtual surround sound field using as few as two front speakers, allowing you to experience listening from 5.1 channel speakers.

This mode is effective not only for 5.1 channel sources but also for stereo(2 channel) sources.

Dolby Virtual Speaker includes two listening mode as follows:

- **Dolby Virtual Speaker Reference**

The width of the front sound image is defined by the actual distance between front speakers.

- **Dolby Virtual Speaker Wide**

The width of the front sound image seems to extend beyond the front speakers.

- When using the EXTERNAL INs to play back the sound from the additional multi-channel decoder for surround sound, you can enjoy the corresponding surround sound, too.( For details, refer to the operating instructions of the component to be connected.)

For your reference, the sound from each channel can be reproduced according to the surround modes as follows:

Modes	Channels	FRONT L/R	CENTER	SURROUND L/R	SURROUND BACK	SUBWOOFER
DTS, DTS 96/24					—	
DTS ES DISCRETE MATRIX						
DTS NEO 6: CINEMA/MUSIC						—(*)
DOLBY DIGITAL					—	
DOLBY DIGITAL EX						
DOLBY PRO LOGIC IIx MOVIE MUSIC						—(*)
DOLBY PRO LOGIC II MOVIE/MUSIC					—	—(*)
DOLBY VIRTUAL SPEAKER					—	—(*)
MPEG					—	
Other Surrounds						—(*)
STEREO			—	—	—	—(*)
EXTERNAL IN						

(\*): Depending on the subwoofer mode setting, the sound from the subwoofer channel may be reproduced.

- Depending on the speaker settings and the number of the encoded channels, etc., the sound from the corresponding channels cannot be reproduced.(For details, refer to “Speaker Setup” on page 18.)

### Dolby Headphone

The Dolby Headphone function simulates 5.1 channel surround sound, which allows you to enjoy 5.1 channel surround sound through 2 channel headphones, just like listening from 5.1 channel speakers.

This mode is effective not only for 5.1 channel sources but also for stereo(2 channel) sources.

Manufactured under license from Dolby Laboratories. “Dolby”, “Pro Logic” and the double-D symbol are trademarks of Dolby Laboratories.

### MPEG Multichannel

This mode is a surround system which faithfully reproduces the ambience and dynamics of movie soundtracks and music alike. Though the number of audio channels are same as Dolby Digital, discs bearing the “ MPEG Multichannel” provides much better at locating individual sounds to the correct and stable position in the sound stage.

- The following modes apply conventional 2-channel signals such as digital PCM or analog stereo signals to high performance Digital Signal Processor to recreate sound fields artificially. Select one of the 3 provided surround modes according to the program source you want to play.

### Theater

This mode provides the effect of being in a movie theater when watching a movie.

### Hall

This mode provides the ambience of a concert hall for classical music sources such as orchestral, chamber music or an instrumental solo.

### Stadium

This mode provides the expansive sound field to achieve the true stadium effect when watching baseball or soccer games.

## ENJOYING SURROUND SOUND

Note:

- Before surround playback, first perform the SPEAKER SETUP procedure, etc. for optimum performance. (For details, refer to "Speaker Setup" on page 18.)

# 1

Depending on the input digital signal format, select the desired decoding mode.

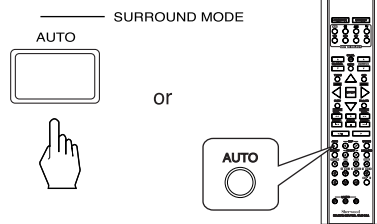

- Each time the AUTO button is pressed, the decoding mode changes as follows :

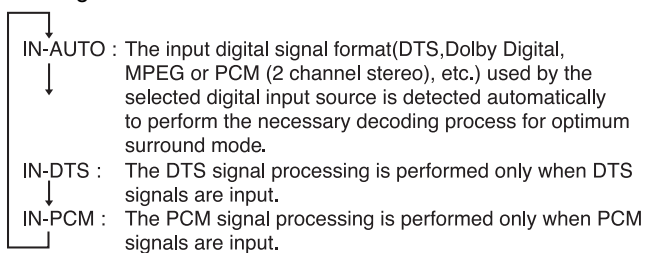

Notes :

- Only when the digital input is selected as signal input for the input sources except TUNER, TAPE, AUX and EXTERNAL IN, the decoding mode can be selected.
- Noise may be generated at the beginning of playback and while searching during DTS playback in the IN-AUTO mode. In this case, try playing in the IN-DTS mode.

# 2

Select the desired surround mode.

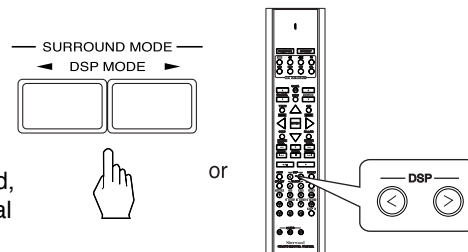

- Each time the DSP MODE (<) or (>) button is pressed, the surround mode changes depending on the input signal format and the selected decoding mode as follows :

Signal format being input	Selected decoding mode	Selectable surround mode
Dolby Digital EX 6.1 channel sources	N-AUTO mode	DOLBY DIGITAL EX, DOLBY D VS REF, DOLBY D VS W DE
Dolby Digital 5.1 channel sources		<DOLBY D PLIix MUSIC>, DOLBY DIGITAL, DOLBY D VS REF, DOLBY D VS W DE
Dolby Digital 2 channel sources		<DOLBY D PLIix MOVIE, DOLBY D PLIix MUSIC,> / [DOLBY D PLII MOVIE, DOLBY D PLII MUSIC,] DOLBY PRO LOGIC, DOLBY D VS REF, DOLBY D VS WIDE
DTS sources	N-AUTO, IN-DTS mode	(DTS +NEO: 6,) corresponding DTS mode, DOLBY VS REF, DOLBY VS WIDE
MPEG sources	N-AUTO mode	MPEG
96 kHz PCM(2 channel) sources	N-AUTO, IN-PCM mode	DOLBY PLII MOVIE, DOLBY PLII MUSIC, DOLBY PRO LOGIC, DOLBY VS REF, DOLBY VS WIDE
PCM( 2 channel ) sources		<DOLBY PLIix MOVIE, DOLBY PLIix MUSIC,> / [DOLBY PLII MOVIE, DOLBY PLII MUSIC,] DOLBY PRO LOGIC, DOLBY VS REF, DOLBY VS WIDE, NEO: 6 C NEMA, NEO: 6 MUSIC, THEATER, HALL, STADIUM
Analog stereo sources	—	

• Depending on surround back speaker setting, some surround modes can be selected or not as follows:

<>: Possible only when surround back speaker is not set to "None".

[ ]: Possible only when surround back speaker is set to "None".

( ): Possible only when surround back speaker is not set to "None" while playing the digital signals from DTS sources except DTS ES 6.1 channel sources.

Notes:

- When the selected decoding mode is not matched to the input signal format, the "DIGITAL" indicator flickers and no sound is heard. Therefore, be sure to select the required decoding mode and the available surround mode according to the input signal format.
- When the EXTERNAL IN is selected as an input source, the decoding and surround modes cannot be selected.
- When the digital signals are not inputted, the desired surround mode cannot be selected.

Continued

**To cancel the surround mode for stereo operation**

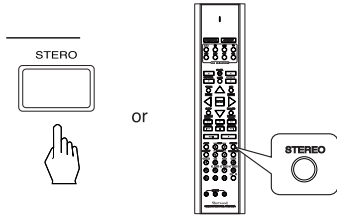

- Depending on the signal format which is being input, either the stereo mode or the 2CH downmix mode is selected.
- To cancel either the stereo mode or the 2 CH downmix mode, select the desired surround mode with using the DSP MODE (<) or (>) button.

**2CH downmix mode**

- This mode allows the multi-channel signals encoded in DTS, Dolby Digital or MPEG format to be mixed down into 2 front channels and to be reproduced through only two front speakers or through headphones.
- When the SPEAKER button is set to off to listen with headphones, if the STEREO button is pressed while playing the multi-channel digital signals from DTS or Dolby Digital sources, it will enter the 2 CH downmix mode automatically.
- To cancel the 2 CH downmix mode, select the desired Dolby Headphone mode with using the DSP MODE (<) or (>) button. (For details, refer to the following "Listening in a Dolby Headphone mode" procedure.)

**Listening in a Dolby Headphone mode**

- The Dolby Headphone function simulates 5.1 channel surround sound, which allows you to enjoy 5.1 channel surround sound through 2 channel headphones, just like listening from 5.1 channel speakers.  
 Note : Only when the SPEAKER button is set to off, the Dolby Headphone mode can be selected. However, in case of playing the digital signals from MPEG source, either the stereo mode or the 2CH downmix mode will be automatically selected depending on its signal format.
- While listening with headphones, select the desired Dolby Headphone mode.

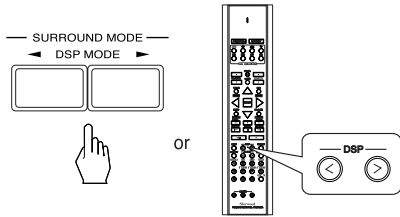

- Each time the DSP MODE (<) or (>) button is pressed, the mode changes as follows :
  - DH 1 : This simulates the soundfield as if you were in a relatively small room with less reverberations.
  - ↕
  - DH 2 : This simulates the soundfield as if you were in a typical listening room with moderate reverberations.
  - ↕
  - DH 3 : This simulates the soundfield as if you were in a large space like theater.

In case of playing analog stereo, PCM 2 channel or Dolby Digital 2 channel source in a Dolby Headphone mode, press the PARAMETER button to select the desired listening mode.

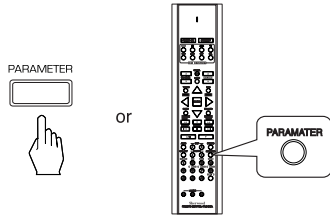

- Each time this button is pressed, the mode changes as follows :
  - MOVIE : This provides the surround effect suitable for movie sources.
  - ↓
  - MUSIC 1 : This provides the surround effect suitable for music sources.
  - ↓
  - MUSIC 2 : This provides less surround effect compared to MUSIC 1 mode.

**Adjusting the Dolby Pro Logic Ix/Dolby Pro Logic II Music parameters**

- When selecting the Dolby Pro Logic Ix Music mode or the Dolby Pro Logic II Music mode, you can adjust the various surround parameters for optimum surround effect.

**1** Press the PARAMETER button to select the desired parameter.

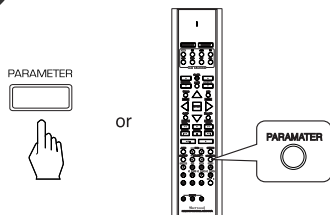

- Each time this button is pressed, the parameter changes and is displayed for several seconds as follows;

**Panorama mode("PANO", default value : OFF)**

This mode extends the front stereo image to include the surround speakers for an exciting "wraparound" effect with side wall imaging. Select "OFF" or "ON".

**Center width control("C-WID", default value : 0)**

This adjusts the center image so it may be heard only from the center speaker, only from the left/right speakers as a phantom image, or from all three front speakers to varying degrees.

The control can be set in 8 steps from 0 to 7.

**Dimension control("DIMEN", default value : -1)**

This gradually adjusts the soundfield either towards the front or towards the rear. The control can be set in 7 steps from -4 to +2.



**2** At the desired parameter, adjust it as desired.

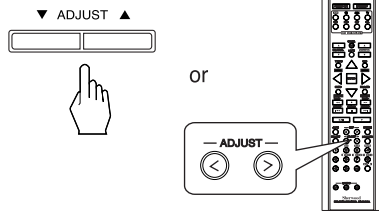

- If the parameter display disappears, start from the step again.

**3** Repeat the above steps and to adjust other parameters.

### Selecting the desired speaker layout for Dolby Virtual Speaker mode

- When selecting the Dolby Virtual Speaker Reference mode (“DOLBY (D) VS REF”) or the Dolby Virtual Speaker Wide mode (“DOLBY (D) VS WIDE”), you can select the desired one of different speaker layouts for actual speakers to be used.
- Press the PARAMETER button to select the desired speaker layout.

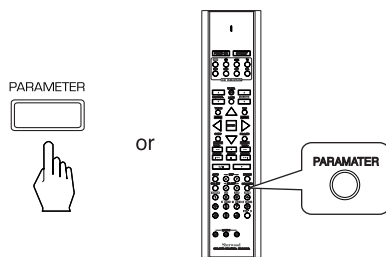

- Each time this button is pressed, the speaker layout mode changes depending on the selected Dolby Virtual Speaker mode as follows:

\* In case of Dolby Virtual Speaker Reference mode,

2 SPK : When using 2 front speakers only



3 SPK : When using 2 front and center speakers

\* In case of Dolby Virtual Speaker Wide mode,

2 SPK : When using 2 front speakers only



3 SPK : When using 2 front and center speakers



4 SPK : When using 2 front and 2 surround speakers



5 SPK : When using 2 front, center and 2 surround speakers

Note : When the speakers are set to “None”, the corresponding speaker layout modes cannot be selected.

### Adjusting each channel level with test tone

- The volume level of each channel can be adjusted easily with the test tone function.

Note : When the EXTERNAL IN is selected as an input source, the SPEAKER button is set to off or it is in the stereo mode, the test tone function does not work.

**1** Enter the test tone mode.

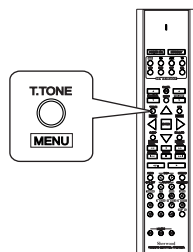

- The test tone will be heard from the speaker of each channel for 2 seconds as follows:

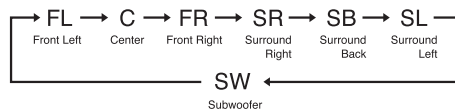

- When the speaker setting is “N”, the test tone of the corresponding channel is not available.



- 2** At each channel, adjust the level as desired until the sound level of each speaker is heard to be equally loud.

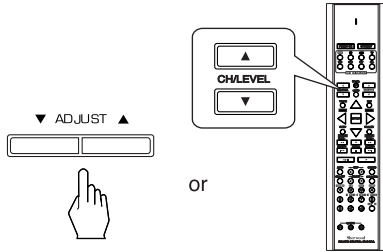

- You can select the desired channel and adjust its level with repeating the steps and in "Adjusting the current channel level" procedure.

- 3** Cancel the test tone function.

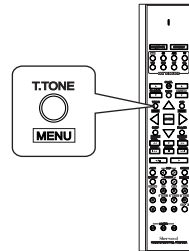

### Adjusting the current channel level

- After adjusting each channel level with test tone, adjust the channel levels either according to the program sources or to suit your tastes.
- You can adjust the current channel levels as desired. These adjusted levels are just memorized into user's memory ("USER"), not into preset memory ("REF. 1", "REF. 2").

- 1** Press the CHANNEL SELECTOR button.

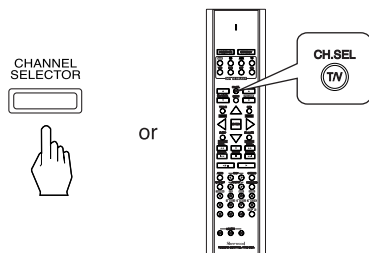

- Each time this button is pressed, "REF. 1" (or "USER") is displayed and the corresponding channel is selected as follows:

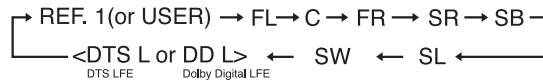

- Depending on the speaker setting and surround mode, etc., some channels cannot be selected.
- When the SPEAKER button is set to off, only the front L/R channel can be selected.

- 2** Adjust the level of the selected channel as desired.

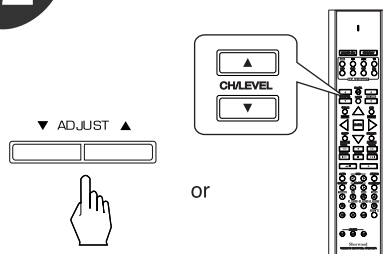

- The LFE level can be adjusted within the range of -10~0 dB and other channel levels within the range of -15~+15 dB.
- In general, we recommend the LFE level to be adjusted to 0 dB.(However, the recommended LFE level for some early DTS software is -10 dB.) If the recommended levels seem too high, lower the setting as necessary.
- If the channel display disappears, start from the step again.

- 3** Repeat the above steps and to adjust each channel level.

## Memorizing the adjusted channel levels

- You can memorize the adjusted channel levels into preset memory (“REF. 1”, “REF. 2”) and recall the memorized whenever you want.

**1** After performing the steps ~ in “Adjusting the current channel level” procedure on page 32, press the (MEMORY/) ENTER button.

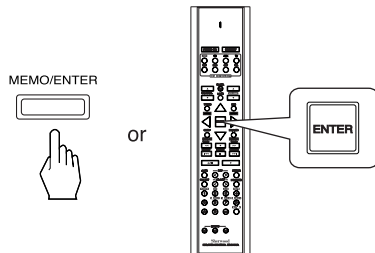

- The “1” of “REF. 1” indication flickers.

**2** Select the desired one of REF. 1 and REF. 2.

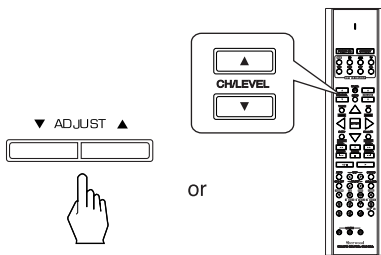

**3** Confirm your selection.

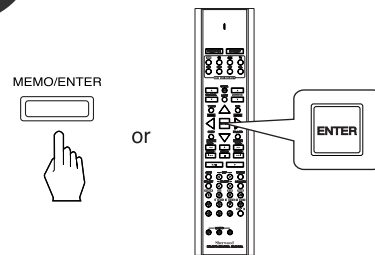

- The adjusted channel levels have now been memorized into the selected memory.

## Recalling the memorized channel levels

**1** Press the CHANNEL SELECTOR button.

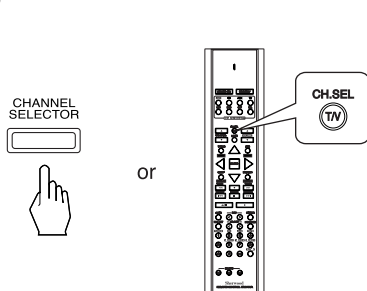

- “REF.1” (or “USER”) is displayed for several seconds.
- If the channel level mode display disappears, press the CHANNEL SELECTOR button again.

**2** Select the desired one of REF. 1 and REF. 2.

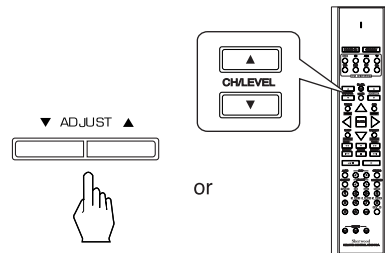

- Then the channel levels memorized into the selected preset memory are recalled.

## LISTENING TO RADIO BROADCASTS

### Auto tuning

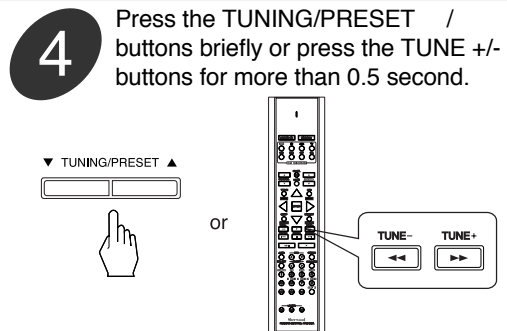
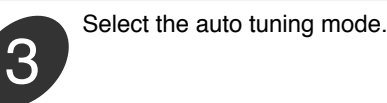
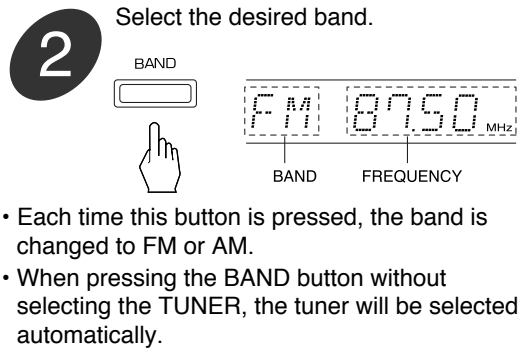
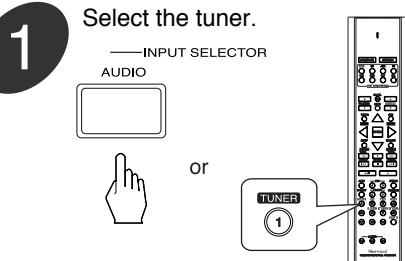

- Each time this button is pressed, the mode changes as follows;

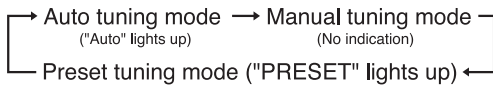

- The tuner will now search until a station of sufficient strength has been found. The display shows the tuned frequency and "TUNED".
- If the station found is not the desired one, simply repeat this operation.
- Weak stations are skipped during auto tuning.
- When pressing the TUNE +/- buttons for more than 0.5 second on the remote control, you need not select the auto tuning mode on step .

### Manual tuning

- Manual tuning is useful when you already know the frequency of the desired station.
- Select the manual tuning mode performing the steps to in "Auto tuning" procedure and press the TUNING/PRESET / or TUNE +/- buttons repeatedly until the right frequency has been reached.
- When pressing the TUNE +/- buttons repeatedly on the remote control, you need not select the manual tuning mode on step in "Auto tuning" procedure.

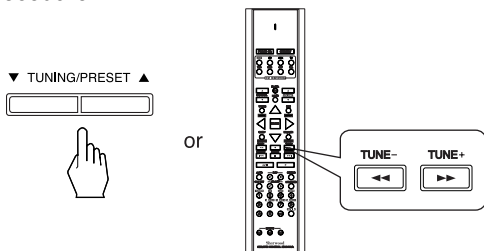

### Presetting radio stations

- You can store up to 30 preferred stations in the memory.

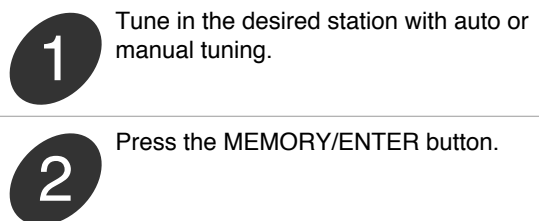

- "MEM" is flickering for several seconds.

**3** Select the desired preset number (1~30) and press the MEMORY/ENTER button.

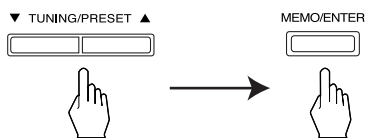

- The station has now been stored in the memory.
- A stored frequency is erased from the memory by storing another frequency in its place.
- If "MEM" goes off, start again from the above step .

**4** Repeat the above steps to memorize other stations.

#### MEMORY BACKUP FUNCTION

The following items, set before the receiver is turned off, are memorized.

- INPUT SELECTOR settings
- Surround mode settings
- Preset stations, etc.

#### Tuning to preset stations

**1** After selecting the tuner as an input source, select the preset tuning mode.

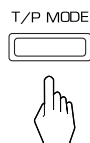

- Then "PRESET" lights up.

**2** Select the desired preset number.

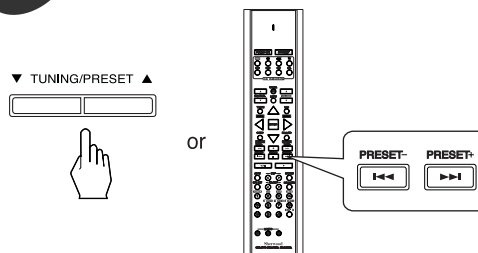

- When pressing the PRESET +/- buttons on the remote control, you need not select the preset tuning mode on step .

#### Listening to FM stereo broadcasts

- While listening to FM broadcasts.

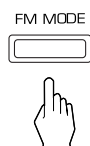

- Each time this button is pressed, the FM mode changes as follows;

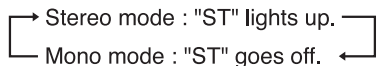

- When FM stereo broadcasts are poor because of weak broadcast signals, select the FM mono mode to reduce the noise, then FM broadcasts are reproduced in monaural sound.

#### Scanning preset stations in sequence

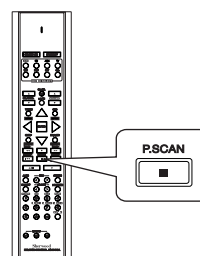

- The receiver will start scanning the stations in the preset sequence and each station is received for 5 seconds.
- At the desired station, press this button again to stop scanning.

## RECORDING

- The analog signals from the EXTERNAL INs as well as the digital signals from the coaxial or optical digital input can be heard but cannot be recorded.
- The volume and tone (bass, treble) settings have no effect on the recording signals.

### Recording with TAPE

- 1 Select the desired input as a recording source except for TAPE.

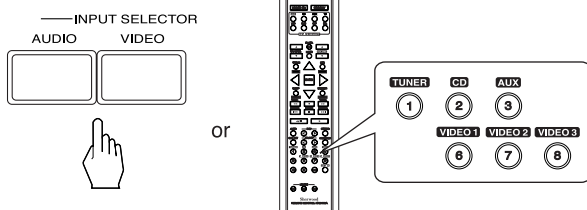

2

Start recording on the TAPE.

3

Start play on the desired input.

### Dubbing from video components onto VIDEO 1

- 1 Select VIDEO 2 or VIDEO 3 as a recording source.

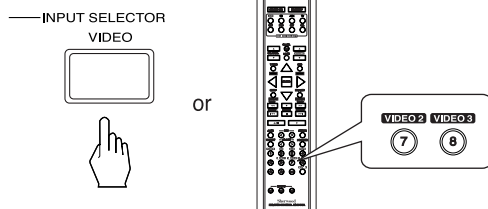

2

Start recording on the VIDEO 1.

3

Start play on the VIDEO 2 or the VIDEO 3.

- The audio and video signals from the VIDEO 2 or the VIDEO 3 will be dubbed onto the VIDEO 1 and you can enjoy them on the TV set and from the speakers.

### Dubbing the audio and video signals separately onto VIDEO 1

Example) When dubbing the VIDEO 2 video signal and the CD audio signal separately onto VIDEO 1.

- 1 Select VIDEO 2 as a video recording source.

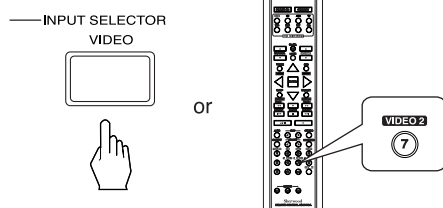

2

Select CD as an audio recording source.

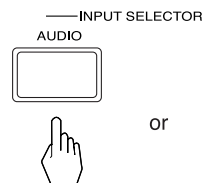



<p><b>3</b> Start recording on the VIDEO 1.</p>	<p><b>4</b> Start play on the VIDEO 2 and the CD respectively.</p> <ul style="list-style-type: none"> <li>The audio signal from the CD and the video signal from the VIDEO 2 will be dubbed and you can enjoy them on the TV set and from the speakers.</li> </ul> <p>Note : Be sure to observe the order of the above steps and .</p>
---	--

**DIGITAL AUDIO RECORDING WITH MD RECORDER**

• Only when the OPTICAL DIGITAL OUT of this receiver is connected to the OPTICAL DIGITAL IN of the MD recorder or CD recorder, you can enjoy high-quality sound of digital recording without converting the original signals. Refer to “CONNECTING VIDEO COMPONENTS”, “CONNECTING AUDIO COMPONENTS” and “CONNECTING DIGITAL INs and OUT” on pages 5~6 and the operating instructions of the MD recorder or CD recorder.

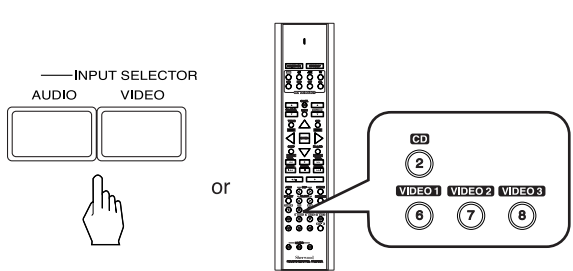
- Notes:**
- Digital recording is available for the digital audio program sources such as CDs, MDs, some DVDs, etc.
  - In most DVDs as well as some CDs, etc., digital recording may not be available depending on the signal format.
  - There are some restrictions on recording digital signals. When making digital recordings, refer to the operating instructions of your digital recording equipment to know what restrictions are imposed.

<p><b>1</b> Select a desired input of CD, VIDEO 1~3 as a recording source.</p> 	<p><b>2</b> For digital recording, select the desired digital input as recording signal input.</p>  <ul style="list-style-type: none"> <li>Each time this button is pressed, the corresponding input is selected as follows:</li> </ul> <pre> graph LR     A[A(nalog)] --&gt; O1[o(ptycal) 1]     O1 --&gt; O2[o(ptycal) 2]     O2 --&gt; C2[c(oaxial) 2]     C2 --&gt; C1[c(oaxial) 1]     C1 --&gt; A   </pre> <p>Note : When the selected digital input is not connected, “DIGITAL” indicator flickers. There will be no recording as well as no sound.</p>
<p><b>3</b> Start recording on the component connected to OPTICAL DIGITAL OUT.</p>	<p><b>4</b> Start play on the desired input.</p>

## OTHER FUNCTIONS

### Compressing the dynamic range (Dolby Digital sources only)

- This function compresses the dynamic range of previously specified parts of the Dolby Digital sound track (with extremely high volume) to minimize the difference in volume between the specified and non-specified parts. This makes it easy to hear all of the sound track when watching movies at night at low levels.
- When the digital signals from Dolby Digital program source are input in available surround mode.



- Each time this button is pressed, the mode changes and the display scrolls.

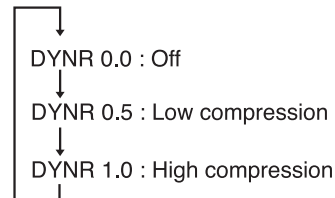

- In some Dolby Digital softwares, this function may not be available.

### Operating the sleep timer

- The sleep timer allows the system to continue to operate for a specified period of time before automatically shutting off.
- To set the receiver to automatically turn off after the specified period of time.

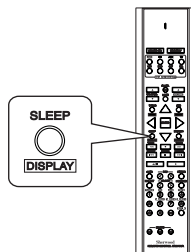

- Each time this button is pressed, the sleep time changes as follows:

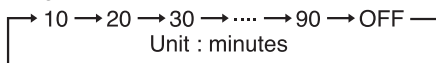

- While operating the sleep timer " \* " lights up.
- When the sleep time is selected, all display panels of Sherwood components connected by the DIGI LINK III are dimly lit.

### Adjusting the brightness of the fluorescent displays

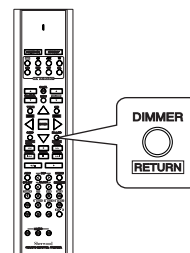

- Each time this button is pressed, the brightness of all fluorescent displays of Sherwood components connected by the DIGI LINK III changes together as follows;

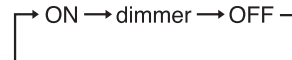

- In the display OFF mode, pressing any button will restore the display ON mode.

## Using the OSD

This unit incorporates an OSD(On-screen display) function to provide information about basic operation of this unit and to simplify the setup procedures.

The OSD function uses a monitor TV connected to this unit as a display and has two kinds of display modes such as current status display and menu screen.

Notes: • Any on-screen display shown on the monitor TV will not be recorded.

- Because this unit cannot support the OSD function for the progressively scanned video signal, the OSD for current status and menu settings may be displayed abnormally or may not be displayed.

### CURRENT STATUS DISPLAY

This mode shows the status corresponding to each operation.

- The on-screen display will automatically disappear in several seconds.
- For examples, there are 2 status displays as follows.

Notes

- When watching a movie earnestly, if you want to turn off the current status display function, set the OSD auto display mode to Off(For details, refer to “When selecting the AUTO OSD” on page 40)

Current status display function might not operate as expected if :

- You view a movie via MONITOR COMPONENT OUTs while component video signals are input into this receiver.
- You view a movie via MONITOR COMPOSITE OUT while S-Video signals and composite video signals are input into this receiver.

When selecting the desired input source

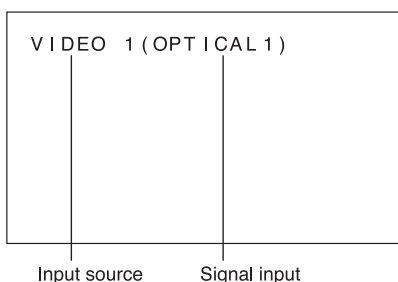

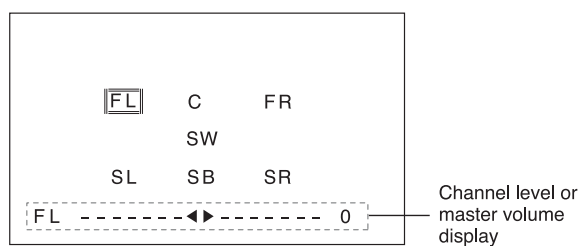

When selecting the TEST TONE mode



- When adjusting overall volume, the volume level display will be shown.
- The test tone display will be shown until the test tone mode is canceled.

## OSD Menu Settings

- The OSD menu allows you to perform the setup procedures easily. In most situations, you will only need to set this once during the installation and layout of your home theater, and it rarely needs to be changed later. The OSD menu consists of 5 main menus : speaker setup, function select, surround mode, CH level setup and auto OSD. Some of these menus are divided into sub-menus.

- The OSD menu settings are performed easily with the CURSOR control(  ,  ,  ,  ), OSD and ENTER buttons.

Notes :

- In such a case of making only COMPONENT VIDEO connections between this receiver and video component, while viewing a movie via the MONITOR COMPONENT OUTs, if the OSD menu operation is performed, the picture is automatically turned off and only the OSD menu is displayed.
- When S-Video signals and composite video signals are input into this receiver, even though the OSD menu operation is performed, the OSD menu cannot be displayed via MONITOR COMPOSITE OUT.





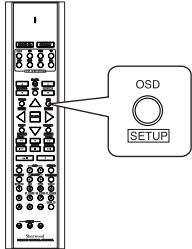

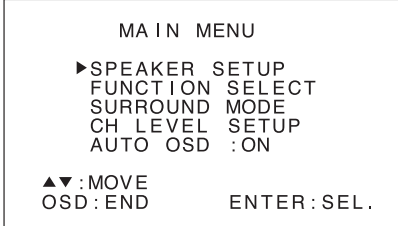

1

Turn the menu screen on.





- The main menu will be shown.
- To turn the menu screen off, press this button again.

- In the bottom of the display, “OSD” stands for the OSD button. “ENTER” for “ENTER”, “”, “”, “”, and “” for CURSOR UP(  ), DOWN(  ), LEFT(  ) and RIGHT(  ).



- 2** Select the desired menu using the CURSOR UP( )/DOWN( ) buttons.

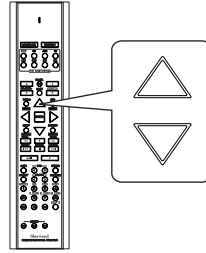

- 3** Confirm your selection.

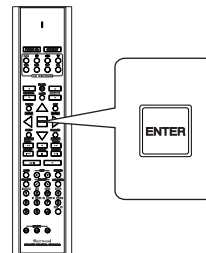

**When selecting the SPEAKER SETUP**

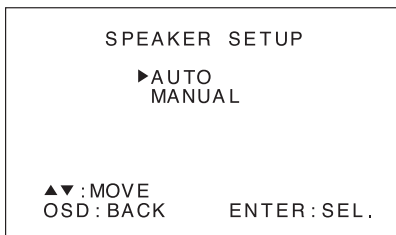

**When selecting the FUNCTION SELECT**

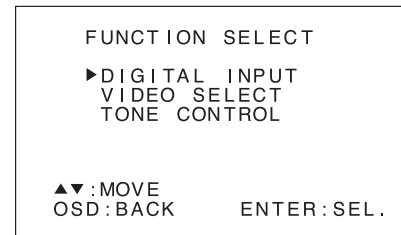

**When selecting the SURROUND MODE**

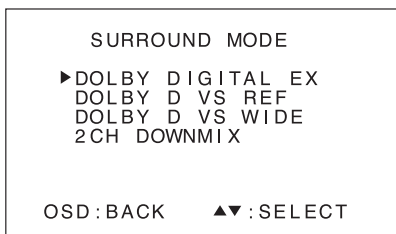

**When selecting the CH LEVEL SETUP**

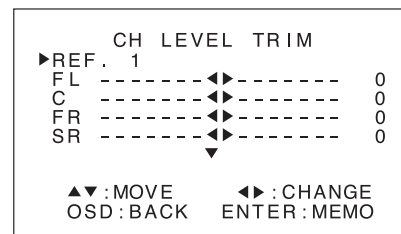

- For the setting details, see page in .
- Adjust the setting(s) in each setting category to your preference.
- When the OSD button is pressed on a sub-menu, the previous menu is resumed.

**When selecting the AUTO OSD**

- Each time the ENTER button is pressed, the AUTO OSD mode is set to ON to turn on the current display or OFF to turn it off.
- When the AUTO OSD mode is set to ON, the current status display overlays the program image on the monitor TV and may interference with your movie enjoyment. In such a case, set it to OFF.

## SETTING THE SPEAKER SETUP

- After you have installed this receiver and connected all the components, you should adjust the speaker settings for the optimum sound acoustics according to your environment and speaker layout.
- Even when you change speakers, speaker positions, or the layout of your listening environment, you should adjust the speaker settings, too.

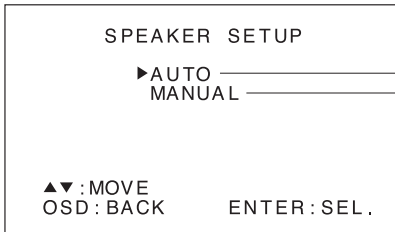

- To set the speaker setup automatically(Auto Speaker Setup)
- To set the speaker setup manually(Manual Speaker Setup)

### Note:

- Because the microphone for Auto Speaker Setup is designed for use with this receiver, to use the auto speaker setup function, do not use a microphone other than the one supplied with this receiver.

### When selecting the AUTO SPEAKER SETUP

- Auto Speaker Setup lets you avoid troublesome listening-based speaker setup and achieve good surround sound. You should connect the supplied microphone to the SETUP MIC jack so that this receiver can analyze the information from a series of test tones emitted from speakers and can adjust the size, distance and sound level of each speaker automatically.
- If you want to personalize your speaker setup and channel level setup by making the settings manually, perform the “When selecting the MANUAL SPEAKER SETUP” procedure on page 42, “Adjusting each channel level with test tone” procedure on page 31 and “Adjusting the current channel level” on page 32.

#### Preparations

1. Connect the supplied microphone to the SETUP MIC jack on the rear panel.(For details, refer to “CONNECTING MICROPHONE” on page 9)
2. Place the microphone on a flat level surface at your normal listening position.
  - If possible, use a tripod, etc. to attach the microphone at the same height as your ears would be when you are seated in your listening position.
  - Ensure there are no obstacles between the speakers and the microphone.

- 1 Press the CURSOR UP( )/DOWN( ) buttons to select the AUTO SPEAKER SETUP, then press the ENTER button.

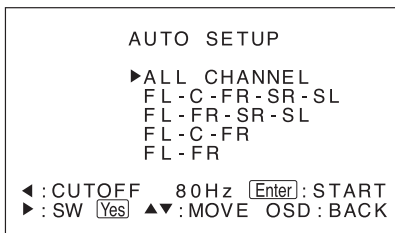
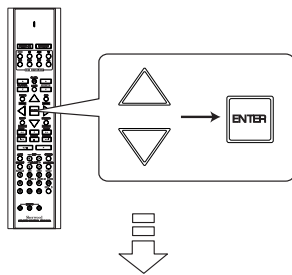

- 2 Press the CURSOR UP( )/DOWN( )/LEFT( )/RIGHT( ) buttons to specify the setting condition according to the number of speakers installed and speakers' frequency characteristics.

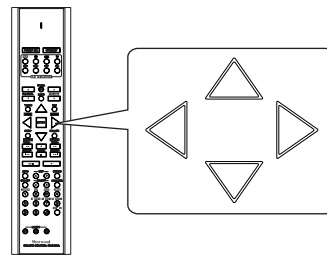

- To specify the layout of the installed speakers, press the CURSOR UP( ) or DOWN( ) button.
- To specify the crossover frequency, press the CURSOR LEFT( ) button. You can specify the crossover frequency with the range of 40~130 Hz in 10 Hz intervals.
- To specify the subwoofer, press the CURSOR RIGHT( ) button.

3

Press the ENTER button to start the auto speaker setup procedure.

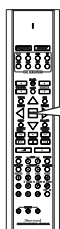

Example) When analyzing the test tones

```

AUTO SETUP
FL C FR
SW
SL SB SR
[Enter] : STOP
  
```

Example) Result report

FL+	0 0dB	10 ft	LARGE
FR+	0 0dB	10 ft	LARGE
C -	- 15dB	10 ft	SMALL
SL+	- 04dB	7 ft	SMALL
SR+	+ 02dB	8 ft	SMALL
SB+	- 05dB	7 ft	SMALL
SW	- 15dB		

Polarity Channel level Speaker distance Speaker size

- Loud test tones are output from each speaker and then if the auto speaker setup procedure has been completed, the results of each adjustment will be displayed.
- To stop the auto speaker setup procedure while outputting the test tones, press the ENTER button.
- If the polarity is incorrect, “-” will be displayed.
- If there may be a problem with the speaker or microphone connection, “ ERROR ” message will be displayed.
- When “ ERROR ” message is displayed, press the CURSOR RIGHT( ) button to retry the auto speaker setup procedure.
- If retrying the procedure dose not fix the problem, turn off the power and check the speaker or microphone connections.

Notes :

- For details on speaker size, crossover frequency and speaker distance, refer to “About the speaker size” and “About the speaker distance” on page 18.
- Because the test tones are very loud, ensure there no infants or small children in the room.
- It is possible to lower the volume of the test tomes, but this could result in incorrect speaker settings.
- For best results, ensure the room is as quiet as possible during the auto speaker setup procedure. If there is too much ambient noise, the results may not be satisfactory.
- If the results are not satisfactory, set the speaker setup manually. (For details, refer to “When selecting the MANUAL SPEAKER SETUP” on page 42)

4

Confirm the results.

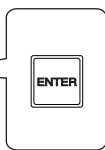

- Then the results are memorized.

### When selecting the MANUAL SPEAKER SETUP

1

Press the CURSOR UP( )/DOWN( ) buttons to select the MANUAL SPEAKER SETUP, then press the ENTER button.

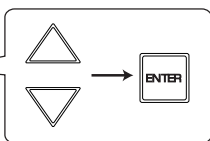

```

MANUAL SETUP
▶SUBWOOFER - YES
FRONT - LARGE
CENTER - LARGE
SURR - LARGE
SURR B - LARGE
▼
▲▼ : MOVE
OSD : BACK
◀▶ : CHANGE
  
```

2

Press the CURSOR UP( )/DOWN( ) buttons to select the desired item.

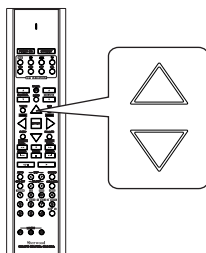

3

Press the CURSOR LEFT( )/RIGHT( ) buttons to set the selected item as desired.

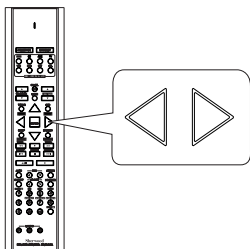

In case of speaker size, you can select one of these following types.

YES/NONE: Select the desired depending on whether a subwoofer is connected or not.

LARGE: Select this when connecting speakers that can fully reproduce sounds below crossover frequency.

SMALL: Select this when connecting speakers that can not fully reproduce sounds below crossover frequency. When this is selected, sounds below crossover frequency are sent to the subwoofer or speakers which are set to LARGE(when not using a subwoofer)

NONE: Select this when no speakers are connected. When this is selected, sounds are sent to the speakers which are not set to NONE.

- Crossover frequency is the frequency(Hz) below which the bass sound of each main speakers is to output from the subwoofer or from speakers which are set to LARGE(when not using a subwoofer).
- Refer to the operating instructions of the speakers to be connected. If the frequency range of your speaker is 100Hz~20kHz, the crossover frequency have to be set to 100Hz(or slightly higher)

In case of speaker distance, you can adjust the distance between the listening position and each speaker within the range of 1~30 feet in 1 foot intervals.

In case of crossover frequency, you can adjust the crossover frequency within the range of 40~130Hz in 10Hz intervals.

Notes :

- When speakers are set to "SMALL", you should set the CROSSOVER FREQUENCY correctly according to their frequency characteristics.
- When "SUBWOOFER" is set to "NONE", "FRONT" is automatically set to "LARGE".
- When the "FRONT" is set to "SMALL", "CENTER", "SURR", "SURR B" cannot be set to "LARGE".
- When the "SURR" is set to "SMALL", "SURR B" cannot be set to "LARGE".
- You cannot adjust the distances of subwoofer and the speakers set to "NONE".

4

Repeat the above steps and until the items are all set to the desired.

5

Confirm your selection.

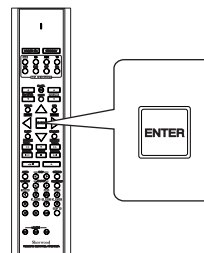

- The adjusted settings are memorized.

## SELECTING THE FUNCTION

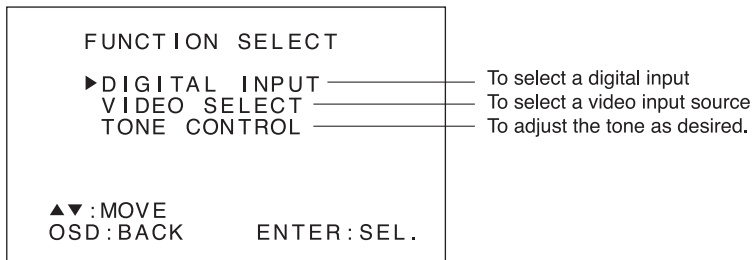

### When selecting the DIGITAL INPUT

Note: When TUNER, TAPE, AUX or EXTERNAL IN is selected as an input source, the DIGITAL INPUT cannot be selected.

- 1** Press the CURSOR UP( )/DOWN( ) buttons to select the DIGITAL INPUT, then press the ENTER button.

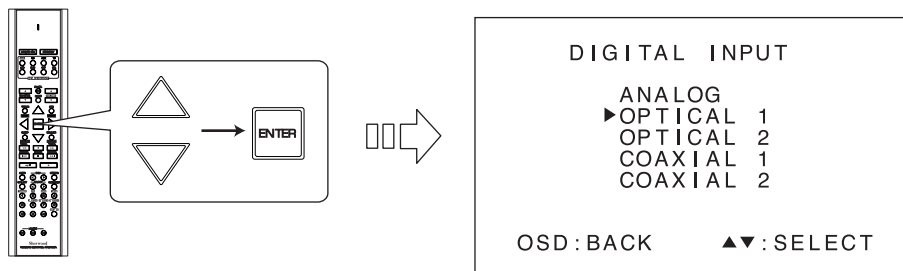

- 2** Press the CURSOR UP( )/DOWN( ) buttons to select the digital or analog input as desired.

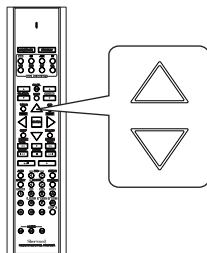

- The sound from the component connected to the selected digital input can be heard regardless of the selected input source.

### When selecting the VIDEO SELECT

- Only when one of TUNER, CD, TAPE, AUX and EXTERNAL IN is selected, you can select a video input source on the VIDEO SELECT menu and enjoy the audio and video signals separately.
- When dubbing them onto VIDEO 1, select either VIDEO2 or VIDEO 3 on the VIDEO SELECT menu.

**1** Press the CURSOR UP( )/DOWN( ) buttons to select the VIDEO SELECT, then press the ENTER button.

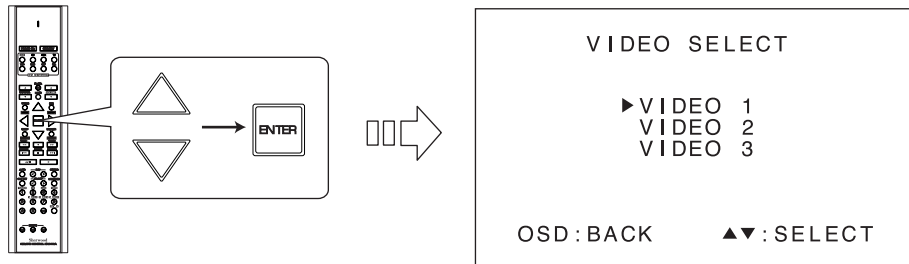

**2** Press the CURSOR UP( )/DOWN( ) buttons to select the desired video input source.

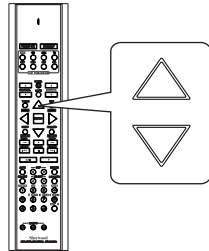

### When selecting the TONE CONTROL

Note: When the digital signals from DTS, Dolby Digital or MPEG program sources are input or the EXTERNAL IN is selected as an input source, you cannot select the TONE CONTROL and can hear a program source without the tone effect.

**1** Press the CURSOR UP( )/DOWN( ) buttons to select the TONE CONTROL, then press the ENTER button.

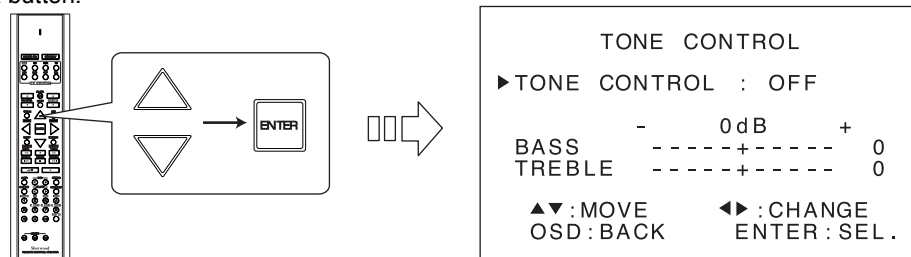

**2** Press the CURSOR UP( )/DOWN( ) buttons to select the desired mode.

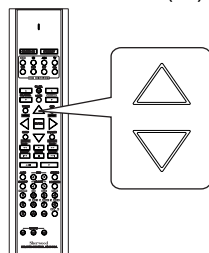

- Note :
- Only when the TONE CONTROL mode is set to on, the tone(BASS and TREBLE)modes can be select.

**3**

Set the selected mode as desired.

When the TONE CONTROL mode is selected, press the ENTER button to select the desired mode.

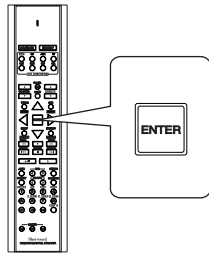

- Each time this button is pressed, the mode changes as follows:  
 ON: When adjusting the tone for your taste.  
 (“DIRECT” indicator goes off.)  
 OFF: When listening to a program source without the tone effect. (“DIRECT” indicator lights up.)

When the BASS or TREBLE mode is selected, press the CURSOR LEFT( )/RIGHT( ) buttons to adjust the tone as desired.

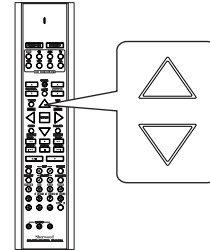

- The tone level can be adjusted within the range of -10 ~+10 dB
- In general, we recommend the bass and treble to be adjusted to 0 dB(flat level)
- Extreme settings at high volume may damage your speakers.
- To complete tone adjustment, repeat the above steps and .

## SELECTING THE SURROUND MODE

Example) When digital signals from Dolby Digital EX 6.1 channel source are input.

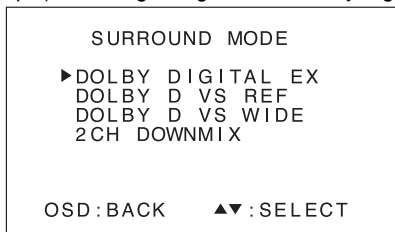

Notes :

- Depending on the input signal format, surround back speaker setting and the selected decoding mode, the selectable surround modes may differ.
- When the EXTERNAL IN is selected as input source, the SURROUND MODE cannot be selected.

- Press the CURSOR UP( )/DOWN( ) buttons to select the desired surround mode.

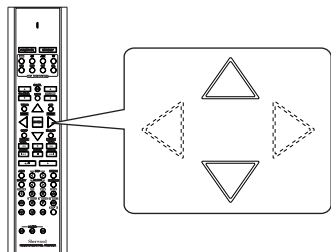

- In case of playing analog stereo, PCM 2 channel or Dolby Digital 2 channel source in a Dolby Headphone mode, press the CURSOR LEFT( )/ RIGHT( ) buttons to select the desired listening mode.

## SETTING THE CH LEVEL SETUP

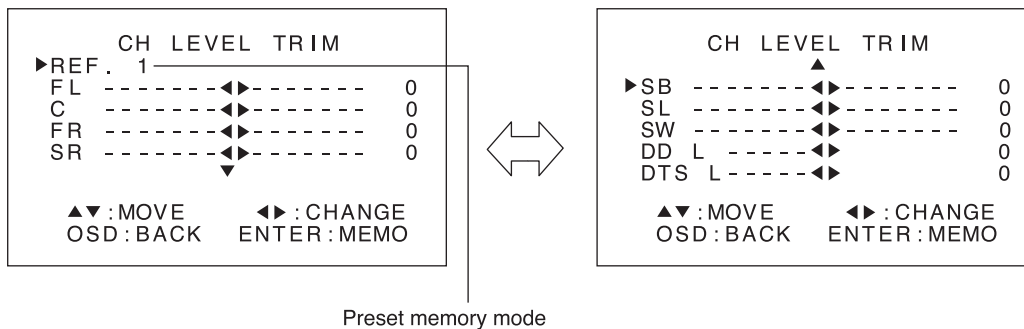

### Notes :

- Depending on the speaker settings and surround mode, etc., some channels cannot be selected.
- When the SPEAKER button is set to off, only the Front Left and Right channels can be selected.
- Only when the digital signals from Dolby Digital or DTS program sources that include LFE signal are input, "DD L"(Dolby Digital LFE) or "DTS L" can be selected.

### Adjusting the current channel level

- You can adjust the current channel levels as desired. These adjusted levels are just memorized into user's memory("USER"), not into preset memory("REF. 1", "REF. 2")
- After adjusting each channel level with test tone, adjust the channel levels either according to the program sources or to suit your tastes.(For details, refer to "Adjusting each channel level with test tone" on page 31.)

1

Press the CURSOR UP( )/DOWN( ) buttons to select the desired channel.

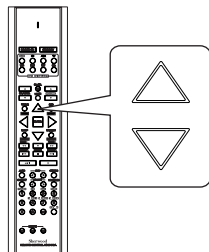

2

Press the CURSOR LEFT( )/RIGHT( ) buttons to adjust the level of the selected channel as desired.

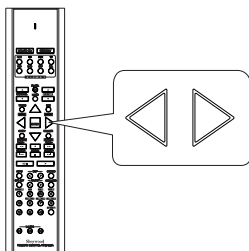

- The LFE level can be adjusted within the range of -10 ~ 0 dB and other channel levels within the range of -15 ~ +15 dB
- In general, we recommend the LFE level to be adjusted to 0 dB.(However, the recommended LFE level for some early DTS software is -10 dB.) If the recommended levels seem too high, lower setting as necessary.

3

Repeat the above steps and to adjust each channel level.



### Memorizing the adjusted channel levels

- You can memorize the adjusted channel levels into preset memory (“REF. 1”, “REF. 2”) and recall the memorized whenever you want.

- 1 After performing the steps ~ in “Adjusting the current channel level” procedure on page 47, press the ENTER button.

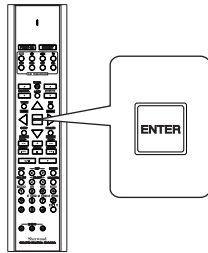

- The “1” of “REF. 1” indication flickers.

- 2 Press the CURSOR LEFT( )/RIGHT( ) buttons to select the desired preset memory, then press the ENTER button.

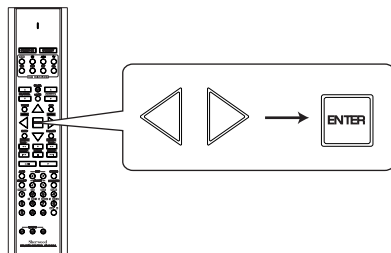

- Each time the CURSOR LEFT( ) or RIGHT( ) button is pressed, “REF. 1” or “REF. 2” is selected.
- The adjusted channel levels has now been memorized into the selected memory.

### Recalling the memorized channel levels

- 1 Press the CURSOR UP( )/DOWN( ) buttons to select the preset memory mode.

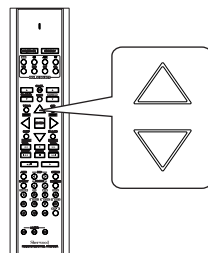

- “USER” may be displayed instead of “REF. 1” or “REF. 2”.

- 2 Press the CURSOR LEFT( )/RIGHT( ) buttons to select the desired one of REF. 1 and REF. 2.

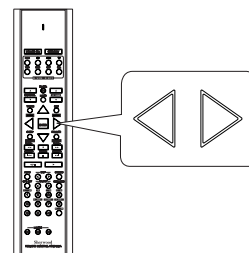

- Then the channel levels memorized into the selected preset memory are recalled.

## Troubleshooting Guide

If a fault occurs, run through the table below before taking your receiver for repair.

If the fault persists, attempt to solve it by switching the receiver off and on again. If this fails to resolve the situation, consult your dealer. Under no circumstances should you attempt to repair the receiver yourself. This could void the warranty.

PROBLEM	POSSIBLE CAUSE	REMEDY
No power	<ul style="list-style-type: none"> <li>The AC input cord is disconnected.</li> <li>Poor connection at AC wall outlet or the outlet is inactive.</li> </ul>	<ul style="list-style-type: none"> <li>Connect the cord securely.</li> <li>Check the outlet using a lamp or another appliance.</li> </ul>
No sound	<ul style="list-style-type: none"> <li>The speaker cords are disconnected.</li> <li>The master volume is adjusted too low.</li> <li>The MUTE button on the remote control is pressed to ON.</li> <li>Speakers are not switched on.</li> <li>Incorrect selection of the input source.</li> <li>Incorrect connections between the components.</li> </ul>	<ul style="list-style-type: none"> <li>Check the speaker connections.</li> <li>Adjust the master volume.</li> <li>Press the MUTE button to cancel the muting effect.</li> <li>Press the SPEAKER button to ON.</li> <li>Select the desired input source correctly.</li> <li>Make connections correctly.</li> </ul>
No sound from the surround speakers	<ul style="list-style-type: none"> <li>Surround mode is switched off(stereo mode).</li> <li>Master volume and surround level are too low.</li> <li>A monaural source is used.</li> <li>Surround speaker setting is "N".</li> </ul>	<ul style="list-style-type: none"> <li>Select a surround mode.</li> <li>Adjust master volume and surround level.</li> <li>Select a stereo or surround source.</li> <li>Select the desired surround speaker setting.</li> </ul>
No sound from the center speaker	<ul style="list-style-type: none"> <li>Dolby Virtual Speaker, stereo mode, etc. is selected.</li> <li>Center speaker setting is "N".</li> <li>Master volume and center level are too low.</li> </ul>	<ul style="list-style-type: none"> <li>Select the desired surround.</li> <li>Select the desired center speaker setting.</li> <li>Adjust master volume and center level.</li> </ul>
No sound from the surround back speaker	<ul style="list-style-type: none"> <li>The input signal format or the current surround mode cannot support the 6.1 surround playback.</li> <li>Master volume and surround back level are too low.</li> <li>Surround back speaker setting is "N".</li> </ul>	<ul style="list-style-type: none"> <li>Under the proper situations, perform the 6.1 surround playback.</li> <li>Adjust master volume and surround back level.</li> <li>Select the desired surround back speaker setting.</li> </ul>
Stations cannot be received	<ul style="list-style-type: none"> <li>No antenna is connected.</li> <li>The desired station frequency is not tuned in.</li> <li>The antenna is in wrong position.</li> </ul>	<ul style="list-style-type: none"> <li>Connect an antenna.</li> <li>Tune in the desired station frequency.</li> <li>Move the antenna and retry tuning.</li> </ul>
Preset stations cannot be received	<ul style="list-style-type: none"> <li>An incorrect station frequency has been memorized.</li> <li>The memorized stations are cleared.</li> </ul>	<ul style="list-style-type: none"> <li>Memorize the correct station frequency.</li> <li>Memorize the stations again.</li> </ul>
Poor FM reception	<ul style="list-style-type: none"> <li>No antenna is connected.</li> <li>The antenna is not positioned for the best reception.</li> </ul>	<ul style="list-style-type: none"> <li>Connect an antenna.</li> <li>Change the position of the antenna.</li> </ul>
Continuous hissing noise during FM reception, especially when a stereo broadcast is received.	<ul style="list-style-type: none"> <li>Weak signals.</li> </ul>	<ul style="list-style-type: none"> <li>Change the position of the antenna.</li> <li>Install an outdoor antenna.</li> </ul>
Continuous or intermittent hissing noise during AM reception, especially at night.	<ul style="list-style-type: none"> <li>Noise is caused by motors, fluorescent lamps or lightning, etc.</li> </ul>	<ul style="list-style-type: none"> <li>Keep the receiver away from noise sources.</li> <li>Install an outdoor AM antenna.</li> </ul>
Remote control unit does not operate.	<ul style="list-style-type: none"> <li>Batteries are not loaded or exhausted.</li> <li>The remote sensor is obstructed.</li> </ul>	<ul style="list-style-type: none"> <li>Replace the batteries.</li> <li>Remove the obstacle.</li> </ul>
Other Sherwood components do not react to remote control commands.	<ul style="list-style-type: none"> <li>DIGI LINK connections are not made properly.</li> </ul>	<ul style="list-style-type: none"> <li>Make proper DIGI LINK connections.</li> </ul>
OSD function is not available	<ul style="list-style-type: none"> <li>Video connections between this unit and the TV monitor are not made correctly.</li> </ul>	<ul style="list-style-type: none"> <li>Make proper video connections.</li> </ul>

# Specifications

## AMPLIFIER SECTION

• Power output stereo mode, 6Ω, THD 0.2%, 40Hz ~ 20 KHz	2 X 100 W
• Total harmonic distortion, 6Ω, 95 W, 1 KHz	0.09 %
• Intermodulation distortion	
60 Hz : 7 KHz = 4 : 1 SMPTE, 6Ω, 95 W	0.1 %
• Input sensitivity / impedance	
Line (CD, TAPE, VIDEO)	230 mV/47 KΩ
• Signal to noise ratio, IHF "A" weighted	
Line (CD, TAPE, VIDEO)	90 dB
• Frequency response	
Line (CD, TAPE, VIDEO), 20 Hz~50 KHz	230 mV/47 KΩ
• Out put level	
TAPE REC, 2.2 kΩ	200 mV
• Bass/Treble control, 100 Hz/10 kHz	±10 dB
• Surround mode, only channel driven	
Front power output, 6 Ω, 1 kHz, THD 0.7	110 W+110 W
Center power output, 6 Ω, 1 kHz, THD 0.7 %	110 W
Surround power output, 6 Ω, 1 kHz, THD 0.7 %	110 W+110 W
Surround back power output, 6 Ω, 1 kHz, THD 0.7 %	110 W

## DIGITAL AUDIO SECTION

• Sampling frequency	32, 44.1, 48, 96 kHz
• Digital input level	
Coaxial, 75	0.5 Vp-p
Optical, 660 nm	-15~21 dBm

## VIDEO SECTION

• Video format	NTSC
• Input sensitivity(=Output level), 75 Ω	
Video (Composite(normal))	1 Vp-p
S-Video (luminance signal)	1 Vp-p
(chrominance signal)	0.286 Vp-p
Component video (R-Y signal)	0.5 Vp-p
(B-Y signal)	0.5 Vp-p
(Y signal)	1.0 Vp-p

## FM TUNER SECTION

• Tuning frequency range	87.5~108 MHz
• Usable sensitivity, THD 3%, S/N 30 dB	12.8 dBf
• 50 dB quieting sensitivity, mono/stereo	20.2 / 45.3 dBf
• Signal to noise ratio, 65 dBf, mono/stereo	70 / 65 dB
• Total harmonic distortion, 65 dBf, 1 kHz, mono/stereo	0.5 / 0.8 %
• Frequency response, 30 Hz~15 kHz	±3 dB
• Stereo separation, 1 kHz	32 dB
• Capture ratio	4.0 dB
• IF rejection ratio	60 dB

## AM TUNER SECTION

• Tuning frequency range	520~1710 kHz
• Usable sensitivity	500 μV/m
• Signal to noise ratio	40 dB
• Selectivity	25 dB

## GENERAL

• Power supply	120 V ~ 60 Hz
• Power consumption	2.7 A
• Switched AC outlets	TOTAL 100 W, 1 A max.
• Dimensions (W x H x D)	440 x 141 x 330 mm(17-3/8 x 5-1/2 x 13 inches)
• Weight (Net)	10.1 kg (22.3 lbs)

Note: Design and specifications are subject to change without notice for improvements.



Pilot	005	003	006				
Pioneer	022						
Portland	003	006	014				
Prism	008						
Proscan	007						
Proton	025	032					
Pulsar	002	003					
Quasar	008	042	021				
RCA	007	008	041	003	013	015	
	037	038	039	040			
Radio Shack	007	019	021	027	005	025	
	003	011	006				
Realistic	019	021	027	005	025	003	
	011	006					
Runco	002	005	033				
SSS	027	003					
Sampo	005	006					
Samsung	012	005	025	003	011	045	
Samsux	006						
Sansei	030						
Sansui	031						
Sanyo	019						
Scimitsu	003						
Scotch	025						
Scott	028	027	025	003	026		
Sears	007	010	019	020	025	026	
	011	006					
Semivox	027						
Semp	020						
Sharp	041	021	006				
Sherwood	000						
Shogun	003						
Signature	001						
Sony	050						
Soundesign	027	025	026				
Squareview	023						
Starlite	027						
Supreme	050						
Sylvania	010	005					
Symphonic	023						
TMK	025	011	024				
Tandy	041						
Technics	008	042					
Technoi Ace	026						
Techwood	008	011					
Teknika	010	027	017	012	003	026	
	011	001	006	014			
Telefunken	011						
Toshiba	019	020	012				
Totevision	006						
Vector Research	005						
Victor	009						
Vidikron	010						

Vidtech	025	003					
Wards	010	021	005	025	004	003	
	026	011	001				
White Westinghouse	031	034	035				
Yamaha	005	003					
Zenith	002	031	001	014			

*VCR*

Admiral	027	021					
Adventura	000						
Aiko	025						
Aiwa	005	000					
Akai	026						
America Action	025						
America High	004						
Asha	023						
Audiovox	005						
Beaumarck	023						
Bell & Howell	017						
Brocksonic	021						
Broksonic	020	018	021	001			
CCE	015	025					
Calix	005						
Canon	004						
Carver	081						
Cineral	025						
Citizen	005	025					
Colt	015						
Craig	005	012	023	015	024		
Curtis Mathes	013	004	026	028			
Cybernex	023						
Daewoo	010	025					
Denon	008						
Dynatech	000						
Electrohome	005						
Electroponic	005						
Emerex	002						
Emerson	005	020	000	018	009	021	
	001	025					
Fisher	012	017					
Fuji	004	003					
Funai	000						
GE	013	004	027	023			
Garrard	000						
Go Video	052						
GoldStar	005	006					
Gradiente	000						
HI-Q	012						
Harley Davidson	000						
Harman/Kardon	016	006					
Harwood	015						



Magnin	023
Memorex	005 028 (TV use 025)
Mitsubishi	027 (TV use 041)
Orion	001
Panasonic	004 (TV use 008) 028 (TV use 042)
Penney	004 (TV use 008) 023 028 (TV use 042)
Quasar	004 (TV use 008) 028 (TV use 042)
RCA	013 (TV use 012) 004 (TV use 008) 027 (TV use 041)
Sansui	000
Sanyo	023
Sear	000 005
Sharp	027 (TV use 041)
Sony	002 (TV use 000)
Symphonic	000
Zenith	000

**CBL**

ABC	002 003 009 030 007 006 008
Allegro	018 021
Archer	018 026
Bell&Howell	009
Century	018
Citizen	018 021
Comtronics	014
Contec	011
Easten	001
Emerson	026
Everquest	010 014
Focus	022
Garrard	018
Gemini	010
General Instrument	033 276 006 034
GoldStar	017 040
Goodmind	026
Hamlin	012 020 004 013
Hitachi	006
Hytex	007
Jasco	010 018 021
Jerrold	002 007 033 032 009 010 006 034
Memorex	000
Movie Time	015
NSC	015
Oak	011
Optimus	031
Panasonic	000 016 031
Paragon	000
Philips	018
Pioneer	017 025
Popular Mechanics	022
Pulsar	000
Quasar	000
RCA	031
Radio Shack	010 021 026 028
Recoton	022
Regal	012 020
Regency	001
Rembrandt	006
Runco	000
SL Marx	014
Smasung	017 014
Scientific Atlanta	003 023 030 027
Signal	010 014
Signature	006
Sprucer	031
Starcom	002 010

**DVD**

Harman/Kardon	009
JVC	008
Kenwood	005
Megavox	011
Mitsubishi	016
Onkyo	011
Panasonic	013
Philips	011 006
Pioneer	003 014 026
Proscan	002
RCA	002
Samsung	017
Sherwood	001 012 000 018 019 020 021 022 023 025
Sony	004
Technics	013
Theta Digital	014
Toshiba	011
Yamaha	013 007
Zenith	011 010

Stargate	010	014	026
Starquest	010		
TV86	015		
Televue	014		
Tocom	007	008	
Toshiba	000		
Tusa	010		
Unika	018		
United Artists	007		
Universal	153	019	
Viewstar	015		
Zenith	000	024	
Zentek	022		

### SAT

AlphaStar	008		
Chaparral	001		
Echostar	009		
Expreevu	009		
General Instrument	016	015	018
HTS	009		
Hitachi	011		
Hughes Net.Sys	007		
JVC	009		
Jerrold	016	015	
Megavox	006	005	
Memorex	006		
Next Level	006		
Panasonic	017		
Philips	006	005	
Primestar	016	015	
RCA	003	000	002 012
Radio Shack	018		
Realistic	014		
Sony	004		
Star Choice	018		
Toshiba	010		
Uniden	006	005	014
Zenith	013		

### AUX-TAPE/MD

Sherwood	000 (for tape deck)
	035 (for MD recorder)

### AUX-LD

Denon	007	
Mitsubishi	007	
NAD	007	
Pioneer	007	
Sony	017	018

### AUX-TAPE

Aiwa	004	034
Carver	004	
Harman/Kardon	016	004
JVC	022	024
Kenwood	008	
Megavox	004	
Marantz	004	
Onkyo	012	025
Opimus	002	020
Panasonic	038	
Pioneer	002	020 011
Sansui	004	
Sony	021	014 026
Technics	038	
Victor	024	
Wards	002	
Yamaha	010	009

### AUX-AMP

Awia	029	
Carver	023	
Curtis Mathes	027	
Denon	037	
Harman/Kardon	040	
Linn	023	
Megavox	023	
Marantz	023	
Panasonic	039	
Philips	023	040
Pioneer	003	027
Sony	019	033
Technics	039	
Wards	003	
Yamaha	028	



## AUX-HOME AUTOMATION

GE	043
Lutron	044
One For All	042
Radio Shack	043
Security System	042
Universal X10	042
X10	042

## AUX-DBS

Awia	045	059	029
Fisher	005		
Harman/Kardon	046		
JBL	046		
JVC	047		
Jerrold	031		
RCA	006		
Scientific Atlanta	032		
Sony	045		
Starcom	031		

## AUX-ACCESSARY

Archer	013
GC Electronics	013
Jebsee	013
Rabbit	036
Radio Shack	013

## CD

Awia	010	030
Burmester	019	
California Audio Lab	002	
Carver	010	012 020
DKK	001	
Denon	028	034
Emerson	035	
Fisher	012	033
Garrard	019	018
Genexxa	004	035
Harman/Kardon	010	011
Hitachi	004	
JVC	007	

Kenwood	003	029	016	024	025
Krell	010				
LXI	035				
Linn	010				
MCS	002				
MTC	019				
Megavox	010	035			
Marantz	002	010	013		
Mission	010				
NSM	010				
Nikko	033				
Onkyo	008	026			
Opimus	001	004	012	035	029
	019	009	021	020	
Panasonic	002	031			
Parasound	019				
Philips	010	023			
Pioneer	004	035	021	017	
Proton	010				
QED	010				
Quasar	002				
RCA	012	035	006	036	
Realistic	012	019	013		
Rotel	010	019			
SAE	010				
Sansui	010	035			
Sanyo	012				
Scott	035				
Sears	035				
Sharp	029	013	037		
Sherwood	013	027	038	039	040 041
	000				
Sony	001	014	022		
Soundesign	009				
Tascam	019				
Teac	019	018	033	013	
Technics	002	031			
Victor	007				
Wards	010	006			
Yamaha	005	015			
Yorx	032				

# **R-671**

*Audio/Video Receiver*

